

# NETGEAR®

## Nighthawk AC1750 Smart WiFi Router

Model R6700

User Manual



July 2014  
202-11361-01

350 East Plumeria Drive  
San Jose, CA 95134  
USA

## Support

Thank you for selecting NETGEAR products.

After installing your device, locate the serial number on the label of your product and use it to register your product at <https://my.netgear.com>. You must register your product before you can use NETGEAR telephone support. NETGEAR recommends registering your product through the NETGEAR website. For product updates and web support, visit <http://support.netgear.com>.

Phone (US & Canada only): 1-888-NETGEAR.

Phone (Other Countries): Check the list of phone numbers at <http://support.netgear.com/general/contact/default.aspx>.

## Compliance

For regulatory compliance information, visit <http://www.netgear.com/about/regulatory>.

See the regulatory compliance document before connecting the power supply.

## Trademarks

NETGEAR, the NETGEAR logo, and Connect with Innovation are trademarks and/or registered trademarks of NETGEAR, Inc. and/or its subsidiaries in the United States and/or other countries. Information is subject to change without notice.  
© NETGEAR, Inc. All rights reserved.

# Contents

## Chapter 1 Hardware Setup

Unpack Your Router .....	9
Attach the Antennas .....	9
Top and Front Panels .....	10
Rear Panel .....	12
Position Your Router .....	12
Cable Your Router .....	13

## Chapter 2 Connect to the Network and Access the Router

Connect to the Network .....	16
Wired Connection .....	16
WiFi Connection .....	16
Label .....	17
Types of Logins .....	17
Use an Internet Browser to Access the Router .....	17
NETGEAR genie Automatic Internet Setup .....	17
Log In to the Router .....	19
Change the Language .....	19
Access the Router with NETGEAR genie App .....	20

## Chapter 3 Specify Your Internet Settings

Use the Internet Setup Wizard .....	22
Manually Set Up the Internet Connection .....	23
Specify an Internet Connection Without a Login .....	23
Specify an Internet Connection That Uses a Login .....	25
Specify IPv6 Internet Connections .....	27
Requirements for Entering IPv6 Addresses .....	28
Use Auto Detect for an IPv6 Internet Connection .....	28
Use Auto Config for an IPv6 Internet Connection .....	29
Set Up an IPv6 6to4 Tunnel Internet Connection .....	31
Set Up an IPv6 Pass Through Internet Connection .....	32
Set Up an IPv6 Fixed Internet Connection .....	33
Set Up an IPv6 DHCP Internet Connection .....	35
Set Up an IPv6 PPPoE Internet Connection .....	36
Maximum Transmission Unit .....	38
Change the MTU Size .....	39
Common MTU Sizes .....	39

## Chapter 4 Optimize Performance

Prioritize Internet Traffic with Quality of Service	42
Optimize Internet Gaming with Upstream QoS	42
Add Upstream QoS Rules	43
Set Up QoS for Applications and Online Gaming	44
Set Up QoS for a Router LAN Port	46
Set Up QoS for a MAC Address	47
Edit an Upstream QoS Policy	48
Delete an Upstream QoS Policy	49
Optimize Video Streaming with Downstream QoS	50
Add Downstream QoS Rules by Keyword	51
Add a Downstream QoS Rule by Device	52
Improve Network Connections with Universal Plug and Play	53
Wi-Fi Multimedia Quality of Service	54

## Chapter 5 Control Access to the Internet

Set Up Parental Controls	57
Control Access to Your Network	59
Use Keywords to Block Internet Sites	60
Delete Keywords from the List to Be Blocked	61
Block Services from the Internet	62
Schedule When to Block Internet Sites and Services	64
Avoid Blocking on a Trusted Computer	64
Set Up Security Event Email Notifications	65

## Chapter 6 Share USB Drives Attached to the Router

USB Drive Requirements	68
Access a USB Device on the Network	68
Back Up Windows Computers with ReadySHARE Vault	70
Back Up Mac Computers with Time Machine	71
Set Up a USB Hard Drive on a Mac	71
Prepare to Back Up a Large Amount of Data	71
Use Time Machine to Back Up onto a USB Hard Drive	72
Control Access to the USB Drive	73
Use FTP Within the Network	74
View Network Folders on a USB Drive	75
Add a Network Folder on a USB Drive	76
Edit a Network Folder on a USB Drive	77
Approve USB Devices	78
Safely Remove a USB Drive	79

## Chapter 7 Access the Router's USB Drive Through the Internet

Access the USB Drive Through the Internet	82
Set Up FTP Access Through the Internet	82
Access the USB Drive Through the Internet with FTP	83

Dynamic DNS . . . . .	84
Your Personal FTP Server . . . . .	84
Set Up a New Dynamic DNS Account . . . . .	85
Specify a DNS Account That You Already Use . . . . .	86
Change the Dynamic DNS Settings . . . . .	88
Set Up Your Personal FTP Server . . . . .	88

## Chapter 8 Use the Router as a Media Server

Specify ReadyDLNA Media Server Settings . . . . .	90
Play Music from a USB Drive with iTunes Server . . . . .	90
Play Media from a USB Drive on TiVo . . . . .	92

## Chapter 9 Share a USB Printer

Install the Printer Driver and Cable the Printer . . . . .	96
Download the ReadySHARE Printer Utility . . . . .	96
Install the ReadySHARE Printer Utility . . . . .	97
Use the Shared Printer . . . . .	98
View or Change the Status of a Printer . . . . .	99
Use the Scan Feature of a Multifunction USB Printer . . . . .	100
Change NETGEAR USB Control Center Settings . . . . .	101

## Chapter 10 Specify Network Settings

Disable LED Blinking or Turn Off LEDs . . . . .	104
View WAN Settings . . . . .	104
Set Up a Default DMZ Server . . . . .	106
Change the Router's Device Name . . . . .	107
Change the LAN TCP/IP Settings . . . . .	107
Specify the IP Addresses That the Router Assigns . . . . .	109
Disable the DHCP Server Feature in the Router . . . . .	110
Reserve LAN IP Addresses . . . . .	111
Edit a Reserved LAN IP Address . . . . .	112
Delete a Reserved LAN IP Address . . . . .	113
Use the WPS Wizard for WiFi Connections . . . . .	113
Specify Basic WiFi Settings . . . . .	114
Change the WiFi Security Option . . . . .	116
Set Up a Guest Network . . . . .	117
How the Router Manages Wireless Clients . . . . .	118
Airtime Fairness . . . . .	118
Implicit Beamforming . . . . .	119
Control the Wireless Radios . . . . .	119
Use the WiFi On/Off Button . . . . .	120
Enable or Disable the Wireless Radios . . . . .	120
Set Up a Wireless Schedule . . . . .	121
Specify WPS Settings . . . . .	122
Use the Router as a Wireless Access Point . . . . .	123
Set Up the Router in Bridge Mode . . . . .	124

Set Up a Wireless Distribution System .....	126
Set Up the Base Station .....	128
Set Up a Repeater .....	129

## Chapter 11 Manage Your Network

Update the Router Firmware .....	132
Change the admin Password .....	132
Set Up Password Recovery .....	133
Recover the admin Password .....	134
View Router Status .....	135
Display Internet Port Statistics .....	135
Check the Internet Connection Status .....	137
View Logs of Router Activity .....	138
Monitor Internet Traffic .....	139
Create Custom Static Routes .....	140
Edit a Static Router .....	142
Delete a Static Router .....	142
View Devices Currently on the Network .....	143
Manage the Router Configuration File .....	144
Back Up Settings .....	144
Restore Configuration Settings .....	145
Erase the Current Configuration Settings .....	145
Remote Management .....	146

## Chapter 12 Use VPN to Access Your Network

Set Up a VPN Connection .....	149
Specify VPN Service in the Router .....	150
Install OpenVPN Software on Your Computer .....	150
Use a VPN Tunnel .....	153
Use VPN to Access the Router's USB Drive and Media .....	154
Use VPN to Access Your Internet Service at Home .....	155
Set Up VPN Client Internet Access in the Router .....	155
Block VPN Client Internet Access in the Router .....	156
Use a VPN Tunnel to Access Your Internet Service at Home .....	156

## Chapter 13 Specify Internet Port Settings

Set Up Port Forwarding to a Local Server .....	159
Add a Custom Port Forwarding Service .....	160
Edit a Port Forwarding Service .....	161
Delete a Port Forwarding Entry .....	162
Application Example: Make a Local Web Server Public .....	162
How the Router Implements the Port Forwarding Rule .....	162
Set Up Port Triggering .....	163
Add a Port Triggering Service .....	163
Enable Port Triggering .....	165
Application Example: Port Triggering for Internet Relay Chat .....	165

## Chapter 14 Troubleshooting

Quick Tips .....	168
Sequence to Restart Your Network .....	168
Check Ethernet Cable Connections .....	168
Wireless Settings .....	168
Network Settings .....	168
Troubleshoot with the LEDs .....	169
Standard LED Behavior When the Router Is Powered On .....	169
Power LED Is Off or Blinking .....	169
Power LED Stays Amber .....	169
LEDs Never Turn Off .....	170
Internet or Ethernet Port LEDs Are Off .....	170
WiFi LED Is Off .....	170
Cannot Log In to the Router .....	170
Cannot Access the Internet .....	171
Troubleshoot PPPoE .....	172
Troubleshoot Internet Browsing .....	173
Changes Not Saved .....	174
Wireless Connectivity .....	174
Troubleshoot Your Network Using the Ping Utility .....	174
Test the LAN Path to Your Router .....	175
Test the Path from Your Computer to a Remote Device .....	175

## Appendix A Supplemental Information

Factory Settings .....	178
Technical Specifications .....	180

# Hardware Setup

---

# 1

The Nighthawk AC1750 Smart WiFi Router delivers combined WiFi connection speeds up to AC1750 (450 Mbps<sup>1</sup> at 2.4 GHz 802.11n and 1300 Mbps<sup>2</sup> at 5 GHz 802.11ac). Nighthawk is ideal for bandwidth-hungry activities such as online gaming and video streaming, powered by a dual-core 1 GHz processor. High-powered amplifiers with antennas provide WiFi coverage anywhere around your home, inside or out.

For gamers, Nighthawk supports upstream Quality of Service (QoS) optimized for online game play with game consoles like Xbox. For uninterrupted HD streaming media, Nighthawk features downstream QoS to identify and prioritize streaming traffic from websites like Netflix, YouTube, and Hulu Plus.

Nighthawk provides fast central storage, backup, and streaming to every device in your home with the USB 3.0 port (10 times faster than USB 2.0). Sharing content across your network is easy, whether you're accessing stored photos and music or printing wirelessly. Stream your stored media files anywhere on the network to DLNA screens. Share your music to AirPlay-compatible devices from the USB hard drive connected to the router. Use the free NETGEAR ReadySHARE Vault app to back up your Windows computers to a USB hard drive connected to Nighthawk.

This chapter contains the following sections:

- *Unpack Your Router*
- *Attach the Antennas*
- *Top and Front Panels*
- *Rear Panel*
- *Position Your Router*
- *Cable Your Router*

For more information about the topics covered in this manual, visit the support website at <http://support.netgear.com>.

---

1. Maximum wireless signal rate derived from IEEE standard 802.11 specifications. Actual data throughput and wireless coverage will vary. Network conditions and environmental factors, including volume of network traffic, building materials and construction, and network overhead, lower actual data throughput rate and wireless coverage. NETGEAR makes no express or implied representations or warranties about this product's compatibility with any future standards. 802.11ac 1300 Mbps is approximately 3x faster than 802.11n 450 Mbps.  
2. Up to 1300 Mbps wireless speeds achieved when you are connecting to other 802.11ac 1300 Mbps devices.



## Unpack Your Router

Your package contains the following items.

### Nighthawk AC1750 Smart WiFi Router

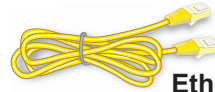

Ethernet cable



Antennas (3)

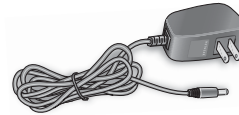

Power adapter

Figure 1. Package contents

## Attach the Antennas

The router comes with three antennas.

### ➤ To attach the antennas:

1. Align the antennas with the antenna posts on the router.

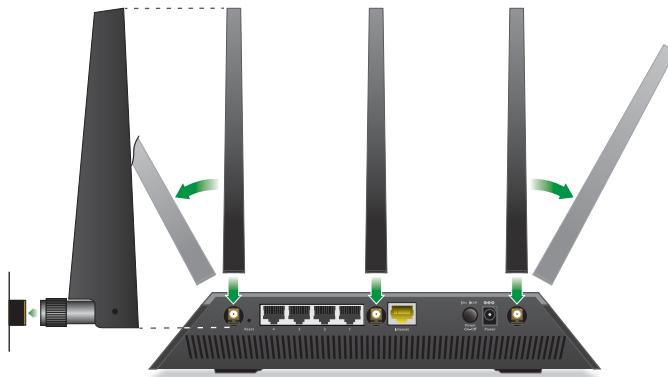

2. Attach the antennas on the threaded antenna posts.
3. Position the antennas for the best WiFi performance.

NETGEAR recommends that the center antenna be vertical and that you aim the others outward at 45-degree angles, as shown.





## Top and Front Panels

Status LEDs are located on top and a USB 3.0 port is located on the front.









Figure 2. Router top and front view

Table 1. LED and button descriptions

LED	Description
Power 	<ul style="list-style-type: none"> <li>• <b>Solid amber.</b> The router is starting.</li> <li>• <b>Blinking amber.</b> The firmware is upgrading or the <b>Reset</b> button was pressed.</li> <li>• <b>Solid white.</b> The router is ready.</li> <li>• <b>Blinking white.</b> The firmware is corrupted.</li> <li>• <b>Off.</b> Power is not supplied to the router.</li> </ul>
Internet 	<ul style="list-style-type: none"> <li>• <b>Solid white.</b> The Internet connection is ready.</li> <li>• <b>Solid amber.</b> The router detects an Ethernet cable connection to the modem.</li> <li>• <b>Off.</b> No Ethernet cable is connected between the router and the modem.</li> </ul>
2.4 GHz Wireless 	<ul style="list-style-type: none"> <li>• <b>Solid white.</b> The 2.4 GHz WiFi radio is operating.</li> <li>• <b>Blinking.</b> The router is sending or receiving WiFi traffic.</li> <li>• <b>Off.</b> The 2.4 GHz WiFi radio is off.</li> </ul>
5 GHz Wireless 	<ul style="list-style-type: none"> <li>• <b>Solid white.</b> The 5 GHz WiFi radio is operating.</li> <li>• <b>Blinking.</b> The router is sending or receiving WiFi traffic.</li> <li>• <b>Off.</b> The 5 GHz WiFi radio is off.</li> </ul>
Guest WiFi 	<ul style="list-style-type: none"> <li>• <b>Solid white.</b> The guest WiFi is operating.</li> <li>• <b>Off.</b> The guest WiFi is off.</li> </ul>

**Table 1. LED and button descriptions (continued)**

LED	Description
USB 3.0 	<ul style="list-style-type: none"> <li>• <b>Solid white.</b> A USB device is connected and is ready.</li> <li>• <b>Blinking.</b> A USB device is plugged in and is trying to connect.</li> <li>• <b>Off.</b> No USB device is connected or someone clicked the <b>Reset</b> button, and it is now safe to remove the attached USB device.</li> </ul>
Ethernet ports 1–4    	The LED color indicates the speed: white for Gigabit Ethernet connections and amber for 100 Mbps or 10 Mbps Ethernet connections. <ul style="list-style-type: none"> <li>• <b>Solid white.</b> A powered-on device is connected to the Ethernet port.</li> <li>• <b>Blinking white.</b> The port is sending or receiving traffic.</li> <li>• <b>Off.</b> No device is connected to this Ethernet port.</li> </ul>
WiFi On/Off button with LED 	Pressing this button for two seconds turns the 2.4 GHz and 5 GHz WiFi radios on and off. If this LED lights solid white, the WiFi radios are on. If this LED is off, the WiFi radios are turned off and you cannot use WiFi to connect to the router.
WPS button with LED 	This button lets you use WPS to join the WiFi network without typing the WiFi password. The WPS LED blinks white during this process and then lights solid white.

You can disable LED blinking or turn off all LEDs except the Power LED. For information about how to do this, see [Disable LED Blinking or Turn Off LEDs](#) on page 104.

## Rear Panel

The connections and buttons shown in the following figure are located on the rear panel.

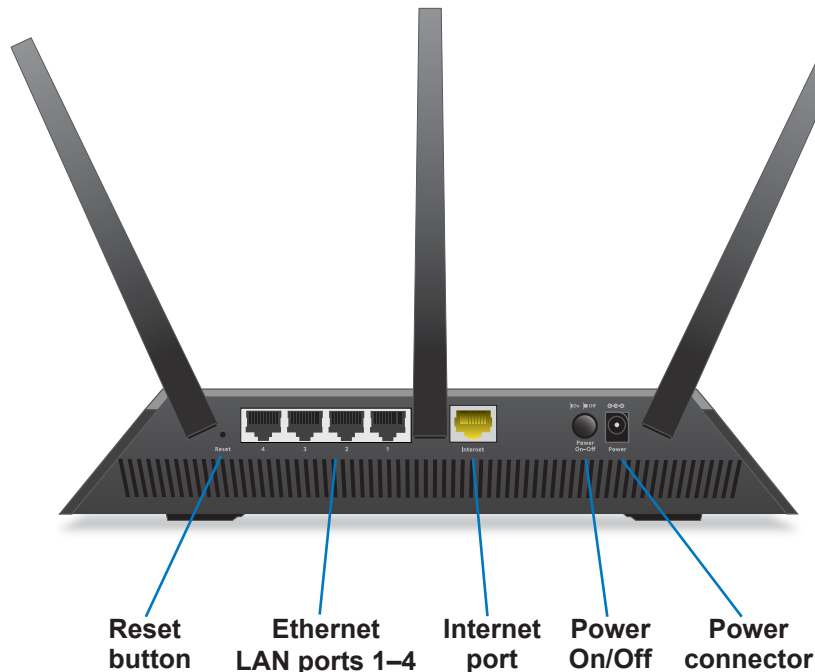

Figure 3. Router rear panel

Pressing the **Reset** button restores the factory settings. See [Factory Settings](#) on page 178.

## Position Your Router

The router lets you access your network anywhere within the operating range of your wireless network. However, the operating distance or range of your wireless connection can vary significantly depending on the physical placement of your router. For example, the thickness and number of walls the wireless signal passes through can limit the range.

Additionally, other wireless access points in and around your home might affect your router's signal. Wireless access points are routers, repeaters, WiFi range extenders, and any other device that emits a wireless signal for network access.

Position your router according to the following guidelines:

- Place your router near the center of the area where your computers and other devices operate and within line of sight to your wireless devices.
- Make sure that the router is within reach of an AC power outlet and near Ethernet cables for wired computers.
- Place the router in an elevated location, minimizing the number walls and ceilings between the router and your other devices.

- Place the router away from electrical devices such as these:
  - Ceiling fans
  - Home security systems
  - Microwaves
  - Computers
  - Base of a cordless phone
  - 2.4 GHz cordless phone
- Place the router away from large metal surfaces, large glass surfaces, insulated walls, and items such as these:
  - Solid metal doors
  - Aluminum studs
  - Fish tanks
  - Mirrors
  - Brick
  - Concrete

## Cable Your Router

The following image shows how to cable your router:

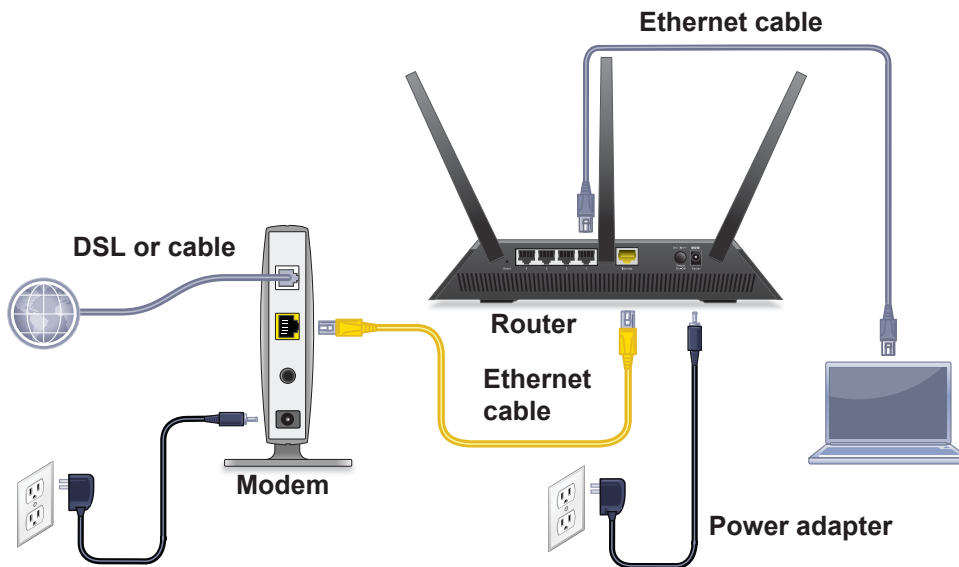

Figure 4. Router cabling

➤ **To cable your router:**

1. Unplug your modem's power, leaving the modem connected to the wall jack for your Internet service.

If your modem uses a battery, remove the battery.

2. Plug in and turn on your modem.

If your modem uses a battery, put the battery back in.

3. Connect your modem to the Internet port of your router with the yellow Ethernet cable that came with your router.

4. Connect the power adapter to your router and plug the power adapter into an outlet.

5. Press the **Power On/Off** button on the rear panel of the router.

# 2

## 2 Connect to the Network and Access the Router

---

You can connect to the router's WiFi network or use a wired Ethernet connection. This chapter explains the ways you can connect and how to access the router and log in.

This chapter contains the following sections:

- *Connect to the Network*
- *Types of Logins*
- *Use an Internet Browser to Access the Router*
- *Change the Language*
- *Access the Router with NETGEAR genie App*

## Connect to the Network

You can connect to the router's network through a wired or WiFi connection. If you set up your computer to use a static IP address, change the settings so that it uses Dynamic Host Configuration Protocol (DHCP).

### Wired Connection

You can connect your computer to the router using an Ethernet cable and join the router's local area network (LAN).

➤ **To connect your computer to the router with an Ethernet cable:**

1. Make sure power is supplied the router (its Power LED is lit).
2. Connect an Ethernet cable to an Ethernet port on your computer.
3. Connect the other end of the Ethernet cable to one of the numbered Ethernet ports.

Your computer connects to the local area network (LAN). A message might display on your computer screen to notify you that an Ethernet cable is connected.

### WiFi Connection

You can connect to the router's WiFi network with Wi-Fi Protected Setup (WPS) or you can find and select the WiFi network.

➤ **To use WPS to connect to the WiFi network:**

1. Make sure power is supplied the router (its Power LED is lit).
2. Check the WPS instructions for your computer or wireless device.
3. Press the **WPS** button on the router.
4. Within two minutes, on your computer or WiFi device, press its **WPS** button or follow its instructions for WPS connections.

Your computer or wireless device connects to the WiFi network.

➤ **To find and select the WiFi network:**

1. Make sure that the router has power (its Power LED is lit).
2. On your computer or wireless device, find and select the WiFi network.

The WiFi network name is on the router's label.

3. Join the WiFi network and enter the WiFi password.

The password is on the router's label.

Your wireless device connects to the WiFi network.



## Label

The label on the router shows the login information, MAC address, and serial number.

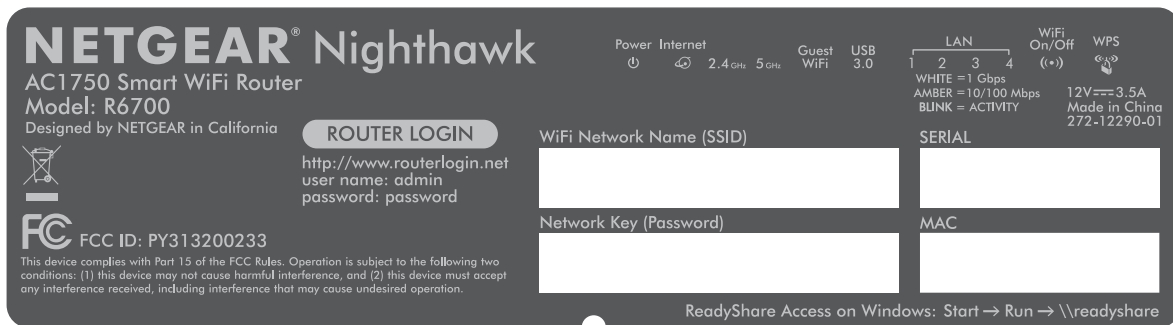

Figure 5. Product label

## Types of Logins

Separate types of logins serve different purposes. It is important that you understand the difference so that you know which login to use when.

Types of logins:

- **ISP login.** The login that your ISP gave you logs you in to your Internet service. Your service provider gave you this login information in a letter or some other way. If you cannot find this login information, contact your service provider.
- **WiFi network key or password.** Your router is preset with a unique wireless network name (SSID) and password for wireless access. This information is on the product label.
- **Router login.** This logs you in to the router interface from an Internet browser as admin.

## Use an Internet Browser to Access the Router

When you connect to the network (either with WiFi or with an Ethernet cable), you can use an Internet browser to access the router to view or change its settings. The first time you access the router, NETGEAR genie automatically checks to see if your router can connect to your Internet service.

## NETGEAR genie Automatic Internet Setup

You can set up your router with the NETGEAR genie automatically, or you can use the genie menus and screens to set up your router manually. Before you start the setup process, get your ISP information and make sure that the computers and devices in the network use the settings described here.

When your Internet service starts, your Internet service provider (ISP) typically gives you all the information needed to connect to the Internet. For DSL service, you might need the following information to set up your router:

- The ISP configuration information for your DSL account
- ISP login name and password
- Fixed or static IP address setting (special deployment by ISP; this setting is rare)

If you cannot locate this information, ask your ISP to provide it. When your Internet connection is working, you no longer need to launch the ISP login program on your computer to access the Internet. When you start an Internet application, your router automatically logs you in.

NETGEAR genie runs on any device with a web browser. Installation and basic setup takes about 15 minutes to complete.

➤ **To use NETGEAR genie to set up your router:**

1. Turn the router on by pressing the **On/Off** button.
2. Make sure that your computer or wireless device is connected to the router with an Ethernet cable (wired) or wirelessly with the preset security settings listed on the label.

**Note:** If you want to change the router's WiFi setting, use a wired connection to avoid being disconnected when the new WiFi settings take effect.

3. Launch an Internet browser.

The screen that displays depends on whether you accessed the router before:

- The first time you set up the Internet connection for your router, the browser goes to <http://www.routerlogin.net>, and the NETGEAR genie screen displays.

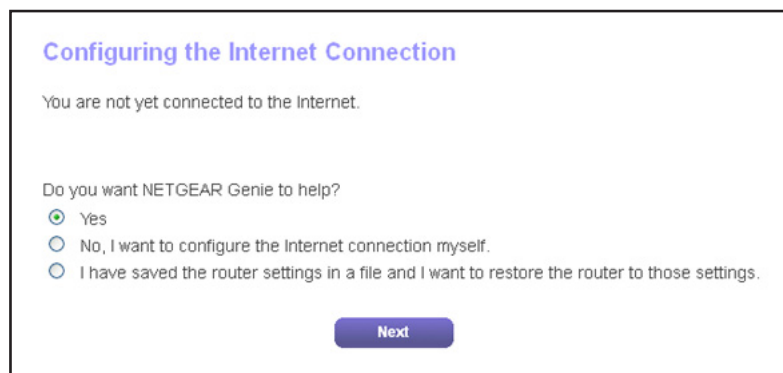

- If you already used the NETGEAR genie, type **<http://www.routerlogin.net>** in the address field for your browser to display. The NETGEAR genie screen displays.
4. Follow the onscreen instructions.  
NETGEAR genie guides you through connecting the router to the Internet.
  5. If the browser cannot display the web page, do the following:

- Make sure that the computer is connected to one of the four LAN Ethernet ports or wirelessly to the router.
  - Make sure that the Power LED is lights solid white.
  - Close and reopen the browser or clear the browser cache.
  - Browse to **http://www.routerlogin.net**.
  - If the computer is set to a static or fixed IP address (this setting is uncommon), change it to obtain an IP address automatically from the router.
6. If the router does not connect to the Internet, do the following:
- a. Review your settings. Make sure that you selected the correct options and typed everything correctly.
  - b. Contact your ISP to verify that you specified the correct configuration information.
  - c. Read *Chapter 14, Troubleshooting*.
- If problems persist, register your NETGEAR product and contact NETGEAR technical support.

## Log In to the Router

When you first set up your router, NETGEAR genie automatically starts when you launch an Internet browser on a computer that is connected to the router. If you want to view or change settings for the router, you can use genie again.

➤ **To log in to the router:**

1. Launch an Internet browser from a computer or wireless device that is connected to the network.
2. Type **http://www.routerlogin.net** or **http://www.routerlogin.com**.

A login screen displays.

3. Enter the router user name and password.

The user name is **admin**. The default password is **password**. The user name and password are case-sensitive.

The BASIC Home screen displays.

## Change the Language

By default, the language is set to **Auto**.

➤ **To change the language:**

1. Launch an Internet browser from a computer or wireless device that is connected to the network.
2. Type **http://www.routerlogin.net** or **http://www.routerlogin.com**.

A login screen displays.

3. Enter the router user name and password.

The user name is **admin**. The default password is **password**. The user name and password are case-sensitive.

The BASIC Home screen displays.

4. In the upper right corner, select a language from the menu.
5. When prompted, click the **OK** button to confirm this change.

The screen refreshes with the language that you selected.

## Access the Router with NETGEAR genie App

The genie app is the easy dashboard for managing, monitoring, and repairing your home network. The genie app can help you with the following:

- Automatically repair common wireless network problems.
- Easily manage router features like Live Parental Controls, guest access, Internet traffic meter, speed test, and more.

### ➤ To use the genie app to access the router:

1. Visit the NETGEAR genie web page at [www.NETGEAR.com/genie](http://www.NETGEAR.com/genie).
2. Follow the onscreen instructions to install the app on your smartphone, tablet, or computer.
3. Launch the genie app.

The genie app dashboard screen displays.

# Specify Your Internet Settings

---

# 3

Usually, the quickest way to set up the router to use your Internet connection is to allow the genie to detect the Internet connection when you first access the router with an Internet browser. You can also customize or specify your Internet settings.

This chapter contains the following sections:

- *Use the Internet Setup Wizard*
- *Manually Set Up the Internet Connection*
- *Specify IPv6 Internet Connections*
- *Maximum Transmission Unit*

## Use the Internet Setup Wizard

You can use the Setup Wizard to detect your Internet settings and automatically set up your router. The Setup Wizard is not the same as the genie screens that display the first time you connect to your router to set it up.

➤ **To use the Setup Wizard:**

1. Launch an Internet browser from a computer or wireless device that is connected to the network.
2. Type **http://www.routerlogin.net** or **http://www.routerlogin.com**.

A login screen displays.

3. Enter the router user name and password.

The user name is **admin**. The default password is **password**. The user name and password are case-sensitive.

The BASIC Home screen displays.

4. Select **ADVANCED > Setup Wizard**.

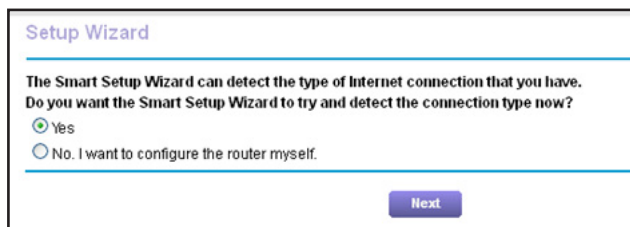

Setup Wizard

The Smart Setup Wizard can detect the type of Internet connection that you have. Do you want the Smart Setup Wizard to try and detect the connection type now?

Yes

No. I want to configure the router myself.

Next

5. Select the **Yes** radio button.

If you select the **No** radio button, you are taken to the Internet Setup screen (see [Manually Set Up the Internet Connection](#) on page 23).

6. Click the **Next** button.

The Setup Wizard searches your Internet connection for servers and protocols to determine your ISP configuration.

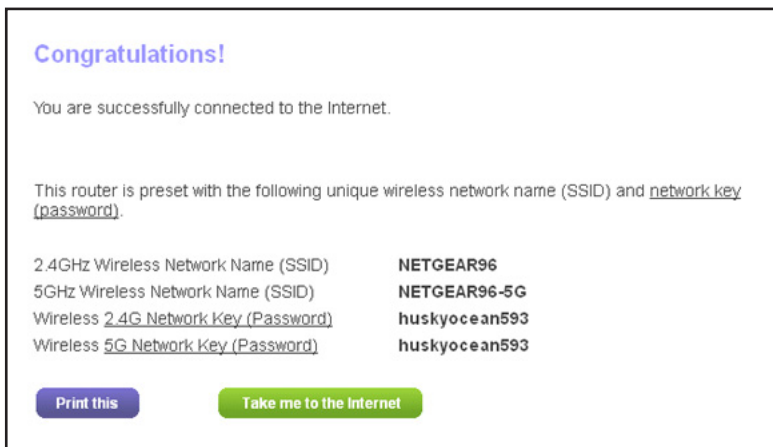

## Manually Set Up the Internet Connection

You can view or change the router's Internet connection settings.

### Specify an Internet Connection Without a Login

➤ **To specify the Internet connection settings:**

1. Launch an Internet browser from a computer or wireless device that is connected to the network.
2. Type **http://www.routerlogin.net** or **http://www.routerlogin.com**.  
A login screen displays.
3. Enter the router user name and password.

The user name is **admin**. The default password is **password**. The user name and password are case-sensitive.

The BASIC Home screen displays.

4. Select **Internet**.

5. In the Does your Internet connection require a login section, leave the **No** radio button selected.
6. If your Internet connection requires an account name or host name, type it in the **Account Name (If Required)** field.
7. If your Internet connection requires a domain name, type it in the **Domain Name (If Required)** field.

For the other sections in this screen, the default settings usually work, but you can change them.

8. Select an Internet IP Address radio button:
  - **Get Dynamically from ISP.** Your ISP uses DHCP to assign your IP address. Your ISP automatically assigns these addresses.
  - **Use Static IP Address.** Enter the IP address, IP subnet mask, and gateway IP address that your ISP assigned. The gateway is the ISP router to which your router connects.
9. Select a Domain Name Server (DNS) Address radio button:
  - **Get Automatically from ISP.** Your ISP uses DHCP to assign your DNS servers. Your ISP automatically assigns this address.
  - **Use These DNS Servers.** If you know that your ISP requires specific servers, select this option. Enter the IP address of your ISP's primary DNS server. If a secondary DNS server address is available, enter it also.
10. Select a Router MAC Address radio button:
  - **Use Default Address.** Use the default MAC address.



- **Use Computer MAC Address.** The router captures and uses the MAC address of the computer that you are now using. You must use the one computer that the ISP allows.
- **Use This MAC Address.** Enter the MAC address that you want to use.

11. Click the **Apply** button.

Your settings are saved.

12. Click the **Test** button to test your Internet connection.

If the NETGEAR website does not display within one minute, see [Chapter 14, Troubleshooting](#).

## Specify an Internet Connection That Uses a Login

➤ **To view or change the basic Internet setup:**

1. Launch an Internet browser from a computer or wireless device that is connected to the network.
2. Type <http://www.routerlogin.net> or <http://www.routerlogin.com>.

A login screen displays.

3. Enter the router user name and password.

The user name is **admin**. The default password is **password**. The user name and password are case-sensitive.

The BASIC Home screen displays.

#### 4. Select Internet.

5. In the Does your Internet connection require a login section, select the **Yes** radio button. The screen adjusts.
6. In the **Internet Service Provider** list, select the encapsulation method: **PPPoE**, **PPPoA**, or **L2TP**.
7. In the **Login** field, enter the login name your ISP gave you. This login name is often an email address.
8. In the **Password** field, type the password that you use to log in to your Internet service.
9. If your ISP requires a service name, type it in the **Service Name (if Required)** field.
10. In the **Connection Mode** list, select **Always On**, **Dial on Demand**, or **Manually Connect**.
11. To change the number of minutes until the Internet login times out, in the **Idle Timeout (In minutes)** field, type the number of minutes. This is how long the router keeps the Internet connection active when no one on the network is using the Internet connection. A value of 0 (zero) means never log out.
12. Select an Internet IP Address radio button:
  - **Get Dynamically from ISP.** Your ISP uses DHCP to assign your IP address. Your ISP automatically assigns these addresses.
  - **Use Static IP Address.** Enter the IP address, IP subnet mask, and gateway IP address that your ISP assigned. The gateway is the ISP router to which your router connects.
13. Select a Domain Name Server (DNS) Address radio button:

- **Get Automatically from ISP.** Your ISP uses DHCP to assign your DNS servers. Your ISP automatically assigns this address.
  - **Use These DNS Servers.** If you know that your ISP requires specific servers, select this option. Enter the IP address of your ISP's primary DNS server. If a secondary DNS server address is available, enter it also.
14. Select a Router MAC Address radio button:
- **Use Default Address.** Use the default MAC address.
  - **Use Computer MAC Address.** The router captures and uses the MAC address of the computer that you are now using. You must use the one computer that the ISP allows.
  - **Use This MAC Address.** Enter the MAC address that you want to use.
15. Click the **Apply** button.
- Your settings are saved.
16. Click the **Test** button to test your Internet connection.
- If the NETGEAR website does not display within one minute, see [Chapter 14, Troubleshooting](#).

## Specify IPv6 Internet Connections

You can set up an IPv6 Internet connection if genie does not detect it automatically.

➤ **To set up an IPv6 Internet connection:**

1. Launch an Internet browser from a computer or wireless device that is connected to the network.
2. Type <http://www.routerlogin.net> or <http://www.routerlogin.com>.  
A login screen displays.
3. Enter the router user name and password.  
The user name is **admin**. The default password is **password**. The user name and password are case-sensitive.  
The BASIC Home screen displays.
4. Select **ADVANCED > Advanced Setup > IPv6**.  
The Basic Settings screen displays.
5. In the **Internet Connection Type** list, select the IPv6 connection type:
  - If your ISP did not provide details, select **IPv6 Tunnel**.
  - If you are not sure, select **Auto Detect** so that the router detects the IPv6 type that is in use.
  - If your Internet connection does not use PPPoE, DHCP, or fixed, but is IPv6, select **Auto Config**.

Your Internet service provider (ISP) can provide this information. For more information about IPv6 Internet connection, see the following sections.

- *Use Auto Detect for an IPv6 Internet Connection* on page 28
- *Use Auto Config for an IPv6 Internet Connection* on page 29
- *Set Up an IPv6 6to4 Tunnel Internet Connection* on page 31
- *Set Up an IPv6 Pass Through Internet Connection* on page 32
- *Set Up an IPv6 Fixed Internet Connection* on page 33
- *Set Up an IPv6 DHCP Internet Connection* on page 35
- *Set Up an IPv6 PPPoE Internet Connection* on page 36

**6.** Click the **Apply** button.

Your changes take effect.

## Requirements for Entering IPv6 Addresses

IPv6 addresses are denoted by eight groups of hexadecimal quartets that are separated by colons. You can reduce any four-digit group of zeros within an IPv6 address to a single zero or omit it. The following errors invalidate an IPv6 address:

- More than eight groups of hexadecimal quartets
- More than four hexadecimal characters in a quartet
- More than two colons in a row

## Use Auto Detect for an IPv6 Internet Connection

➤ **To set up an IPv6 Internet connection through auto detection:**

- 1.** Launch an Internet browser from a computer or wireless device that is connected to the network.
- 2.** Type **http://www.routerlogin.net** or **http://www.routerlogin.com**.

A login screen displays.

- 3.** Enter the router user name and password.

The user name is **admin**. The default password is **password**. The user name and password are case-sensitive.

The BASIC Home screen displays.

- 4.** Select **ADVANCED > Advanced Setup > IPv6**.

The IPv6 screen displays.

- 5.** In the **Internet Connection Type** list, select **Auto Detect**.

The screen adjusts:

The screenshot shows the 'Basic Settings' page for IPv6 configuration. At the top, there are three buttons: 'Apply' (green), 'Cancel' (blue), and 'Status Refresh' (blue). Below these, the 'Internet Connection Type' is set to 'Auto Detect' in a dropdown menu. Underneath, the 'Connection Type' is 'DHCP/Auto Detect'. The 'Router's IPv6 Address On WAN' field shows 'Not Available'. The 'LAN Setup' section shows 'Router's IPv6 Address On LAN' as 'Not Available'. Under 'IP Address Assignment', there are two radio buttons: 'Use DHCP Server' (unselected) and 'Auto Config' (selected). At the bottom, there is a checkbox for 'Use This Interface ID' which is unchecked, followed by four empty input boxes for the interface ID.

The router automatically detects the information in the following fields:

- **Connection Type.** This field indicates the connection type that is detected.
  - **Router's IPv6 Address on WAN.** This field shows the IPv6 address that is acquired for the router's WAN (or Internet) interface. The number after the slash (/) is the length of the prefix, which is also indicated by the underline ( ) under the IPv6 address. If no address is acquired, the field displays Not Available.
  - **Router's IPv6 Address on LAN.** This field shows the IPv6 address that is acquired for the router's LAN interface. The number after the slash (/) is the length of the prefix, which is also indicated by the underline ( ) under the IPv6 address. If no address is acquired, the field displays Not Available.
6. Select an IP Address Assignment radio button:
- **Use DHCP Server.** This method passes more information to LAN devices, but some IPv6 systems might not support the DHCv6 client function.
  - **Auto Config.** This is the default setting.

This setting specifies how the router assigns IPv6 addresses to the devices on your home network (the LAN).

7. (Optional) Select the **Use This Interface ID** check box and specify the interface ID to be used for the IPv6 address of the router's LAN interface.

If you do not specify an ID here, the router generates one automatically from its MAC address.

8. Click the **Apply** button.  
Your settings are saved.

## Use Auto Config for an IPv6 Internet Connection

➤ To set up an IPv6 Internet connection through auto configuration:

1. Launch an Internet browser from a computer or wireless device that is connected to the network.
2. Type <http://www.routerlogin.net> or <http://www.routerlogin.com>.

A login screen displays.

3. Enter the router user name and password.

The user name is **admin**. The default password is **password**. The user name and password are case-sensitive.

The BASIC Home screen displays.

4. Select **ADVANCED > Advanced Setup > IPv6**.

The IPv6 screen displays.

5. In the **Internet Connection Type** list, select **Auto Config**.

The screen adjusts:

The router automatically detects the information in the following fields:

- **Router's IPv6 Address on WAN.** This field shows the IPv6 address that is acquired for the router's WAN (or Internet) interface. The number after the slash (/) is the length of the prefix, which is also indicated by the underline ( ) under the IPv6 address. If no address is acquired, the field displays Not Available.
- **Router's IPv6 Address on LAN.** This field shows the IPv6 address that is acquired for the router's LAN interface. The number after the slash (/) is the length of the prefix, which is also indicated by the underline ( ) under the IPv6 address. If no address is acquired, the field displays Not Available.

6. (Optional) In the **DHCP User Class (If Required)** field, enter a host name.

Most people can leave this field blank, but if your ISP gave you a specific host name, enter it here.

7. (Optional) In the **DHCP Domain Name (If Required)** field, enter a domain name.

You can type the domain name of your IPv6 ISP. Do not enter the domain name for the IPv4 ISP here. For example, if your ISP's mail server is mail.xxx.yyy.zzz, type xxx.yyy.zzz as the domain name. If your ISP provided a domain name, type it in this field. For example, Earthlink Cable might require a host name of home, and Comcast sometimes supplies a domain name.

8. Select an IP Address Assignment radio button:
  - **Use DHCP Server.** This method passes more information to LAN devices, but some IPv6 systems might not support the DHCv6 client function.
  - **Auto Config.** This is the default setting.

This setting specifies how the router assigns IPv6 addresses to the devices on your home network (the LAN).

9. (Optional) Select the **Use This Interface ID** check box and specify the interface ID that you want to be used for the IPv6 address of the router's LAN interface.

If you do not specify an ID here, the router generates one automatically from its MAC address.

10. Click the **Apply** button.

Your settings are saved.

## Set Up an IPv6 6to4 Tunnel Internet Connection

The remote relay router is the router to which your router creates a 6to4 tunnel. Make sure that the IPv4 Internet connection is working before you apply the 6to4 tunnel settings for the IPv6 connection.

### ➤ To set up an IPv6 Internet connection by using a 6to4 tunnel:

1. Launch an Internet browser from a computer or wireless device that is connected to the network.
2. Type <http://www.routerlogin.net> or <http://www.routerlogin.com>.

A login screen displays.

3. Enter the router user name and password.

The user name is **admin**. The default password is **password**. The user name and password are case-sensitive.

The BASIC Home screen displays.

4. Select **ADVANCED > Advanced Setup > IPv6**.

The IPv6 screen displays.

5. In the **Internet Connection Type** list, select **6to4 Tunnel**.

The screen adjusts:

The screenshot shows the 'Basic Settings' configuration page. At the top, there are three buttons: 'Apply' (green), 'Cancel' (blue), and 'Status Refresh' (blue). Below these is the 'Internet Connection Type' dropdown menu, which is currently set to '6to4 Tunnel'. Under the 'Remote 6to4 Relay Router' section, the 'Auto' radio button is selected, and there is a four-digit input field for a static IP address. The 'LAN Setup' section includes 'Router's IPv6 Address On LAN' which displays 'Not Available'. Below that, the 'IP Address Assignment' section has the 'Auto Config' radio button selected. At the bottom, there is a 'Use This Interface ID' checkbox which is unchecked, followed by a four-digit input field.

The router automatically detects the information in the Router's IPv6 Address on LAN field. This field shows the IPv6 address that is acquired for the router's LAN interface. The number after the slash (/) is the length of the prefix, which is also indicated by the underline ( ) under the IPv6 address. If no address is acquired, the field displays Not Available.

6. Select a Remote 6to4 Relay Router radio button:
  - **Auto.** Your router uses any remote relay router that is available on the Internet. This is the default setting.
  - **Static IP Address.** Enter the static IPv4 address of the remote relay router. Your IPv6 ISP usually provides this address.
7. Select an IP Address Assignment radio button:
  - **Use DHCP Server.** This method passes more information to LAN devices but some IPv6 systems might not support the DHCv6 client function.
  - **Auto Config.** This is the default setting.

This setting specifies how the router assigns IPv6 addresses to the devices on your home network (the LAN).

8. (Optional) Select the **Use This Interface ID** check box and specify the interface ID to be used for the IPv6 address of the router's LAN interface.

If you do not specify an ID here, the router generates one automatically from its MAC address.

9. Click the **Apply** button.

Your settings are saved.

## Set Up an IPv6 Pass Through Internet Connection

In pass-through mode, the router works as a Layer 2 Ethernet switch with two ports (LAN and WAN Ethernet ports) for IPv6 packets. The router does not process any IPv6 header packets.



➤ **To set up a pass-through IPv6 Internet connection:**

1. Launch an Internet browser from a computer or wireless device that is connected to the network.
2. Type **http://www.routerlogin.net** or **http://www.routerlogin.com**.  
A login screen displays.
3. Enter the router user name and password.  
The user name is **admin**. The default password is **password**. The user name and password are case-sensitive.  
The BASIC Home screen displays.
4. Select **ADVANCED > Advanced Setup > IPv6**.  
The IPv6 screen displays.
5. In the **Internet Connection Type** list, select **Pass Through**.  
The screen adjusts, but no additional fields display.
6. Click the **Apply** button.  
Your settings are saved.

## Set Up an IPv6 Fixed Internet Connection

➤ **To set up a fixed IPv6 Internet connection:**

1. Launch an Internet browser from a computer or wireless device that is connected to the network.
2. Type **http://www.routerlogin.net** or **http://www.routerlogin.com**.  
A login screen displays.
3. Enter the router user name and password.  
The user name is **admin**. The default password is **password**. The user name and password are case-sensitive.  
The BASIC Home screen displays.
4. Select **ADVANCED > Advanced Setup > IPv6**.  
The IPv6 screen displays.
5. In the **Internet Connection Type** list, select **Fixed**.

The screen adjusts:

6. Configure the fixed IPv6 addresses for the WAN connection:
  - **IPv6 Address/Prefix Length.** The IPv6 address and prefix length of the router WAN interface.
  - **Default IPv6 Gateway.** The IPv6 address of the default IPv6 gateway for the router's WAN interface.
  - **Primary DNS Server.** The primary DNS server that resolves IPv6 domain name records for the router.
  - **Secondary DNS Server.** The secondary DNS server that resolves IPv6 domain name records for the router.

**Note:** If you do not specify the DNS servers, the router uses the DNS servers that are configured for the IPv4 Internet connection on the Internet Setup screen. (See *Manually Set Up the Internet Connection* on page 23.)

7. Select an IP Address Assignment radio button:
  - **Use DHCP Server.** This method passes more information to LAN devices but some IPv6 systems might not support the DHCPv6 client function.
  - **Auto Config.** This is the default setting.

This setting specifies how the router assigns IPv6 addresses to the devices on your home network (the LAN).

8. In the **IPv6 Address/Prefix Length** fields, specify the static IPv6 address and prefix length of the router's LAN interface.

If you do not specify an ID here, the router generates one automatically from its MAC address.

9. Click the **Apply** button.

Your settings are saved.

## Set Up an IPv6 DHCP Internet Connection

➤ **To set up an IPv6 Internet connection with a DHCP server:**

1. Launch an Internet browser from a computer or wireless device that is connected to the network.

2. Type **http://www.routerlogin.net** or **http://www.routerlogin.com**.

A login screen displays.

3. Enter the router user name and password.

The user name is **admin**. The default password is **password**. The user name and password are case-sensitive.

The BASIC Home screen displays.

4. Select **ADVANCED > Advanced Setup > IPv6**.

The IPv6 screen displays.

5. In the **Internet Connection Type** list, select **DHCP**.

The screen adjusts:

The screenshot shows the 'Basic Settings' page for IPv6 configuration. At the top, there are three buttons: 'Apply', 'Cancel', and 'Status Refresh'. Below these, the 'Internet Connection Type' is set to 'DHCP'. There are input fields for 'User Class (if Required)' and 'Domain Name (if Required)', both of which are empty. The 'Router's IPv6 Address On WAN' field shows 'Not Available'. Below this, the 'LAN Setup' section shows 'Router's IPv6 Address On LAN' as 'Not Available'. Under 'IP Address Assignment', the 'Auto Config' radio button is selected, and the 'Use DHCP Server' radio button is unselected. At the bottom, there is a checkbox labeled 'Use This Interface ID' which is unchecked, followed by four empty input boxes.

The router automatically detects the information in the following fields:

- **Router's IPv6 Address on WAN.** This field shows the IPv6 address that is acquired for the router's WAN (or Internet) interface. The number after the slash (/) is the length of the prefix, which is also indicated by the underline ( ) under the IPv6 address. If no address is acquired, the field displays Not Available.
  - **Router's IPv6 Address on LAN.** This field shows the IPv6 address that is acquired for the router's LAN interface. The number after the slash (/) is the length of the prefix, which is also indicated by the underline ( ) under the IPv6 address. If no address is acquired, the field displays Not Available.
6. (Optional) In the **User Class (If Required)** field, enter a host name.

Most people can leave this field blank, but if your ISP gave you a specific host name, enter it here.

7. (Optional) In the **Domain Name (If Required)** field, enter a domain name.

You can type the domain name of your IPv6 ISP. Do not enter the domain name for the IPv4 ISP here. For example, if your ISP's mail server is mail.xxx.yyy.zzz, type xxx.yyy.zzz as the domain name. If your ISP provided a domain name, type it in this field. For example, Earthlink Cable might require a host name of home, and Comcast sometimes supplies a domain name.

8. Select an IP Address Assignment radio button:

- **Use DHCP Server.** This method passes more information to LAN devices but some IPv6 systems might not support the DHCPv6 client function.
- **Auto Config.** This is the default setting.

This setting specifies how the router assigns IPv6 addresses to the devices on your home network (the LAN).

9. (Optional) Select the **Use This Interface ID** check box and specify the interface ID to be used for the IPv6 address of the router's LAN interface.

If you do not specify an ID here, the router generates one automatically from its MAC address.

10. Click the **Apply** button.

Your settings are saved.

## Set Up an IPv6 PPPoE Internet Connection

### ➤ To set up a PPPoE IPv6 Internet connection:

1. Launch an Internet browser from a computer or wireless device that is connected to the network.
2. Type <http://www.routerlogin.net> or <http://www.routerlogin.com>.

A login screen displays.

3. Enter the router user name and password.

The user name is **admin**. The default password is **password**. The user name and password are case-sensitive.

The BASIC Home screen displays.

4. Select **ADVANCED > Advanced Setup > IPv6**.

The IPv6 screen displays.

5. In the **Internet Connection Type** list, select **PPPoE**.

The screen adjusts:

The screenshot shows the 'Basic Settings' configuration page. At the top, there are three buttons: 'Apply', 'Cancel', and 'Status Refresh'. The 'Internet Connection Type' is set to 'PPPoE'. Below this are input fields for 'Login', 'Password', and 'Service Name (If Required)'. The 'Connection Mode' is set to 'Always On'. The 'Router's IPv6 Address On WAN' field shows 'Not Available'. The 'LAN Setup' section includes 'Router's IPv6 Address On LAN' (Not Available) and 'IP Address Assignment' with two radio buttons: 'Use DHCP Server' (unselected) and 'Auto Config' (selected). At the bottom, there is a checkbox for 'Use This Interface ID'.

The router automatically detects the information in the following fields:

- **Router's IPv6 Address on WAN.** This field shows the IPv6 address that is acquired for the router's WAN (or Internet) interface. The number after the slash (/) is the length of the prefix, which is also indicated by the underline ( ) under the IPv6 address. If no address is acquired, the field displays Not Available.
- **Router's IPv6 Address on LAN.** This field shows the IPv6 address that is acquired for the router's LAN interface. The number after the slash (/) is the length of the prefix, which is also indicated by the underline ( ) under the IPv6 address. If no address is acquired, the field displays Not Available.

6. In the **Login** field, enter the login information for the ISP connection.

This is usually the name that you use in your email address. For example, if your main mail account is JerAB@ISP.com, you would type JerAB in this field. Some ISPs (like Mindspring, Earthlink, and T-DSL) require that you use your full email address when you log in. If your ISP requires your full email address, type it in this field.

7. In the **Password** field, enter the password for the ISP connection.
8. In the **Service Name** field, enter a service name.

If your ISP did not provide a service name, leave this field blank.

**Note:** The default setting of the **Connection Mode** field is **Always On** to provide a steady IPv6 connection. The router never terminates the connection. If the connection is terminated, for example, when the modem is turned off, the router attempts to reestablish the connection immediately after the PPPoE connection becomes available again.

9. Select an IP Address Assignment radio button:
  - **Use DHCP Server.** This method passes more information to LAN devices but some IPv6 systems might not support the DHCv6 client function.
  - **Auto Config.** This is the default setting.

This setting specifies how the router assigns IPv6 addresses to the devices on your home network (the LAN).

10. (Optional) Select the **Use This Interface ID** check box and specify the interface ID to be used for the IPv6 address of the router's LAN interface.

If you do not specify an ID here, the router generates one automatically from its MAC address.

11. Click the **Apply** button.

Your settings are saved.

## Maximum Transmission Unit

The maximum transmission unit (MTU) is the largest data packet a network device transmits. When one network device communicates across the Internet with another, the data packets travel through many devices along the way. If a device in the data path uses a lower MTU setting than the other devices, the data packets must be split or "fragmented" to accommodate the device with the smallest MTU.

The best MTU setting for NETGEAR equipment is often the default value. In some situations, changing the value fixes one problem but causes another. Leave the MTU unchanged unless one of these situations occurs:

- You experience problems connecting to your ISP or other Internet service, and the technical support of either the ISP or NETGEAR recommends changing the MTU setting. These web-based applications might require an MTU change:
  - A secure website that does not open, or displays only part of a web page
  - Yahoo email
  - MSN portal
  - America Online's DSL service
- You use VPN and have severe performance problems.
- You used a program to optimize MTU for performance reasons, and now you have connectivity or performance problems.

---

**Note:** An incorrect MTU setting can cause Internet communication problems. For example, you might not be able to access certain websites, frames within websites, secure login pages, or FTP or POP servers.

---

## Change the MTU Size

➤ **To change the MTU size:**

1. Launch an Internet browser from a computer or wireless device that is connected to the network.
2. Type <http://www.routerlogin.net> or <http://www.routerlogin.com>.

A login screen displays.

3. Enter the router user name and password.

The user name is **admin**. The default password is **password**. The user name and password are case-sensitive.

The BASIC Home screen displays.

4. Select **ADVANCED > Setup > WAN Setup**.

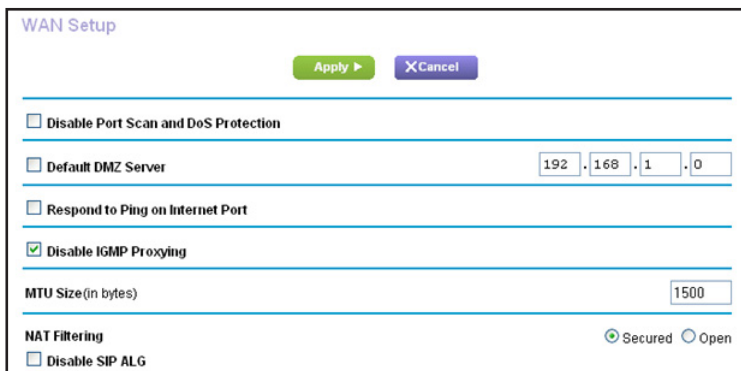

5. In the **MTU Size** field, enter a value from 64 to 1500.
6. Click the **Apply** button.

Your change is saved.

## Common MTU Sizes

If you suspect an MTU problem, a common solution is to change the MTU to 1400. If you are willing to experiment, you can gradually reduce the MTU from the maximum value of 1500 until the problem goes away. The following table describes common MTU sizes and applications.

**Table 2. Common MTU sizes**

MTU	Application
1500	The largest Ethernet packet size. This setting is typical for connections that do not use PPPoE or VPN, and is the default value for NETGEAR routers, adapters, and switches.
1492	Used in PPPoE environments.
1472	Maximum size to use for pinging. (Larger packets are fragmented.)

**Table 2. Common MTU sizes (continued)**

MTU	Application
1468	Used in some DHCP environments.
1460	Usable by AOL if you do not use large email attachments, for example.
1436	Used in PPTP environments or with VPN.
1400	Maximum size for AOL DSL.
576	Typical value to connect to dial-up ISPs.



# Optimize Performance

---

# 4

You can set up the router to optimize performance for applications such as multiplayer gaming, peer-to-peer connections, or real-time communications such as instant messaging or remote assistance (a feature in Windows XP). By default, the router uses Wi-Fi Multimedia Quality of Service (WMM QoS).

This chapter contains the following sections:

- *Prioritize Internet Traffic with Quality of Service*
- *Optimize Internet Gaming with Upstream QoS*
- *Add Upstream QoS Rules*
- *Optimize Video Streaming with Downstream QoS*
- *Improve Network Connections with Universal Plug and Play*
- *Wi-Fi Multimedia Quality of Service*

## Prioritize Internet Traffic with Quality of Service

You can use Quality of Service (QoS) to assign a high priority to gaming and streaming video from the Internet.

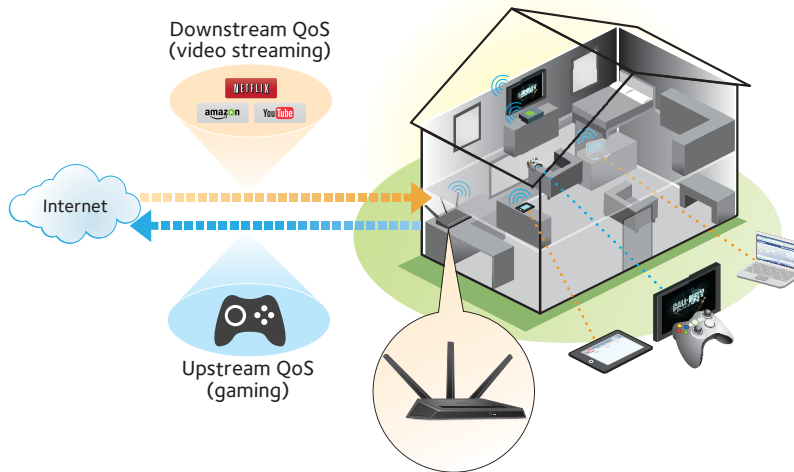

Figure 6. You can prioritize downstream traffic, upstream traffic, or both

## Optimize Internet Gaming with Upstream QoS

Upstream Quality of Service (QoS) assigns a high priority to Internet traffic from your Xbox gaming system.

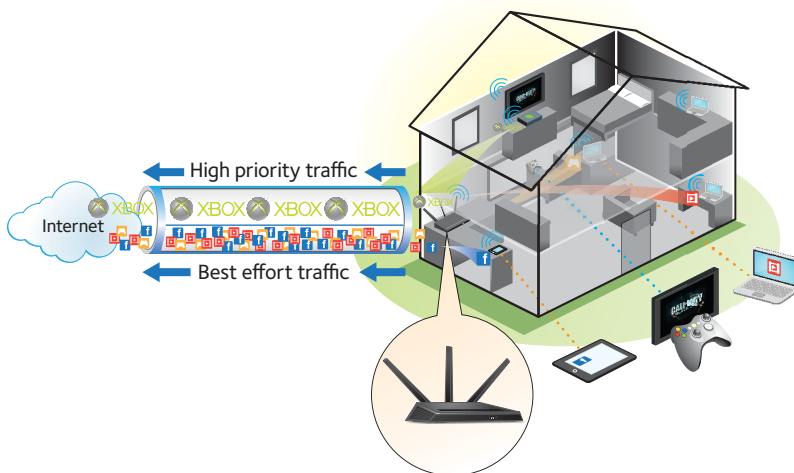

Figure 7. Upstream QoS assigns high priority to gaming traffic from your Xbox

NETGEAR recommends that only gamers enable the Upstream QoS feature. If you do not game and you turn on this feature, some applications might not perform as well as usual.

➤ **To enable upstream QoS:**

1. Launch an Internet browser from a computer or wireless device that is connected to the network.

2. Type **http://www.routerlogin.net** or **http://www.routerlogin.com**.

A login screen displays.

3. Enter the router user name and password.

The user name is **admin**. The default password is **password**. The user name and password are case-sensitive.

The BASIC Home screen displays.

4. Select **ADVANCED > Setup > QoS Setup > Upstream QoS**.

5. Select the **Enable Upstream QoS (Optimized for Gaming)** check box.

6. Specify the maximum uplink bandwidth for your Internet connection:

- If you know what your uplink bandwidth is, type it in the **Uplink bandwidth Maximum** field.
- If you are not sure, click the **Speedtest** button.

Speedtest verifies the upstream speed of your Internet connection. The **Uplink bandwidth Maximum** field displays the result of the test.

7. Click the **Apply** button.

The router assigns a high priority to Internet traffic from your gaming devices to the Internet.

## Add Upstream QoS Rules

You can give prioritized Internet access to the following types of traffic:

- Specific applications
- Specific online games
- Individual Ethernet LAN ports of the router
- A specific device by MAC address

To specify prioritization of traffic, create a policy for the type of traffic and add the policy to the QoS Policy table in the QoS Setup screen. For convenience, the QoS Policy table lists many common applications and online games that can benefit from QoS handling.

## Set Up QoS for Applications and Online Gaming

➤ **To create a QoS policy for applications and online games:**

1. Launch an Internet browser from a computer or wireless device that is connected to the network.
2. Type <http://www.routerlogin.net> or <http://www.routerlogin.com>.

A login screen displays.

3. Enter the router user name and password.

The user name is **admin**. The default password is **password**. The user name and password are case-sensitive.

The BASIC Home screen displays.

4. Select **ADVANCED > Setup > QoS Setup > Upstream QoS**.

The screenshot shows the 'QoS Setup' interface. At the top, there are three tabs: 'WMM', 'Upstream QoS' (which is selected and highlighted), and 'Downstream QoS'. Above the tabs are 'Apply' and 'Cancel' buttons. Below the tabs, there is a checkbox labeled 'Enable Upstream QoS (Optimized for Gaming)' which is checked. Underneath this checkbox is a field for 'Uplink bandwidth: Maximum' with the value '0' and a unit dropdown set to 'Kbps'. To the right of this field is a 'Speedtest' button and the 'OOKLA' logo. At the bottom left, there is a section titled 'OoS Priority Rule list' with a 'Setup QoS rule' button.

5. Click the **Setup QoS rule** button.

The QoS Priority Rule list displays.

#	QoS Policy	Priority	Description
1	MSN Messenger	High	MSN Messenger Applications
2	Skype	Highest	Skype Applications
3	Yahoo Messenger	High	Yahoo Messenger Applications
4	IP Phone	Highest	IP Phone Applications
5	Vonage IP Phone	Highest	Vonage IP Phone Applications
6	NetMeeting	High	NetMeeting Applications
7	AIM	High	AIM Applications
8	Google Talk	Highest	Google Talk Applications
9	Netgear EVA	Highest	Netgear EVA Applications
10	SSH	High	SSH Applications
11	Telnet	High	Telnet Applications
12	VPN	High	VPN Applications
13	FTP	Normal	FTP Applications
14	SMTP	Normal	SMTP Applications
15	WWW	Normal	WWW Applications
16	DNS	Normal	DNS Applications
17	ICMP	Normal	ICMP Applications
18	eMule / eDonkey	Low	eMule / eDonkey Applications

- To add a priority rule, scroll down to the bottom of the QoS Setup screen and click the **Add Priority Rule** button.

**QoS - Priority Rules**

Apply Cancel

**Priority**

QoS Policy for:

Priority Category: Online Gaming

Applications: Add a new game

Priority: Normal

---

**Specified Port Range**

Connection Type: TCP/UDP

Starting Port:  (1 ~65535)

Ending Port:  (1 ~65535)

- In the **QoS Policy for** field, type the name of the application or game.
- In the **Priority Category** list, select either **Applications** or **Online Gaming**.  
A list of applications or games displays.
- Scroll and select **Add a New Application** or **Add a New Game**, as applicable.
- If prompted, in the **Connection Type** list, select either **TCP**, **UDP**, or **TCP/UDP (both)**.
- Specify the port number or range of port numbers that the application or game uses.
- From the **Priority** list, select the priority for Internet access for this traffic relative to other applications and traffic.  
The options are **Low**, **Normal**, **High**, and **Highest**.
- Click the **Apply** button.  
The rule is saved.

## Set Up QoS for a Router LAN Port

- **To create a QoS policy for a device connected to one of the router's LAN ports:**
  1. Launch an Internet browser from a computer or wireless device that is connected to the network.
  2. Type **http://www.routerlogin.net** or **http://www.routerlogin.com**.  
A login screen displays.
  3. Enter the router user name and password.  
The user name is **admin**. The default password is **password**. The user name and password are case-sensitive.  
The BASIC Home screen displays
  4. Select **ADVANCED > Setup > QoS Setup**.  
The QoS Setup screen displays.
  5. Select the **Turn Internet Access QoS On** check box.
  6. Select **ADVANCED > Setup > QoS Setup > Upstream QoS**.

QoS Setup

Apply Cancel

WMM Upstream QoS Downstream QoS

Enable Upstream QoS (Optimized for Gaming)

Uplink bandwidth: Maximum 0 Kbps Speedtest

POWERED BY OOKLA

QoS Priority Rule list Setup QoS rule

7. Click the **Setup QoS Rule** button.  
The QoS Priority Rule list displays.
8. Scroll down and click the **Add Priority Rule** button.  
The QoS - Priority Rules screen displays.
9. From the **Priority Category** list, select **Ethernet LAN Port**.

QoS - Priority Rules

Apply Cancel

**Priority**

QoS Policy for LAN Port 1

Priority Category Ethernet LAN Port

LAN Port 1

Priority Normal

10. From the **QoS Policy for** list, select the LAN port.
11. From the **Priority** list, select the priority for Internet access for this port's traffic relative to other applications.

The options are **Low**, **Normal**, **High**, and **Highest**.

12. Click the **Apply** button.

The rule is saved in the QoS Policy list.

## Set Up QoS for a MAC Address

- **To create a QoS policy for traffic from a specific MAC address:**

1. Launch an Internet browser from a computer or wireless device that is connected to the network.
2. Type **http://www.routerlogin.net** or **http://www.routerlogin.com**.

A login screen displays.

3. Enter the router user name and password.

The user name is **admin**. The default password is **password**. The user name and password are case-sensitive.

The BASIC Home screen displays.

4. Select **ADVANCED > Setup > QoS Setup > Upstream QoS**.

5. Click the **Setup QoS Rule** button.

The QoS Priority Rule list displays.

6. Scroll down and click the **Add Priority Rule** button.

The QoS - Priority Rules screen displays.

7. From the **Priority Category** list, select **MAC Address**.

QoS - Priority Rules

Apply Cancel

**Priority**

QoS Policy for

Priority Category **MAC Address**

**MAC Device List**

	QoS Policy	Priority	Device Name	MAC Address
<input type="radio"/>	Pri_MAC_GD8F19	Normal	techpubs	00:1A:6B:6D:8F:19

MAC Address

Device Name

Priority **Normal**

8. If the device is in the MAC Device List, select its radio button.

The information from the MAC Device List populates the **QoS Policy for**, **MAC Address**, and **Device Name** fields. If the device is not in the MAC Device List, click the **Refresh** button. If it still does not display, complete these fields.

9. From the **Priority** list, select **Highest**.

This is the priority for Internet access for this device's traffic relative to other applications and traffic. The options are **Low**, **Normal**, **High**, and **Highest**.

10. Click the **Apply** button.

This rule is saved.

## Edit an Upstream QoS Policy

### ➤ To edit a QoS policy:

1. Launch an Internet browser from a computer or wireless device that is connected to the network.
2. Type <http://www.routerlogin.net> or <http://www.routerlogin.com>.

A login screen displays.

3. Enter the router user name and password.

The user name is **admin**. The default password is **password**. The user name and password are case-sensitive.

The BASIC Home screen displays.



4. Select **ADVANCED > Setup > QoS Setup > Upstream QoS**.

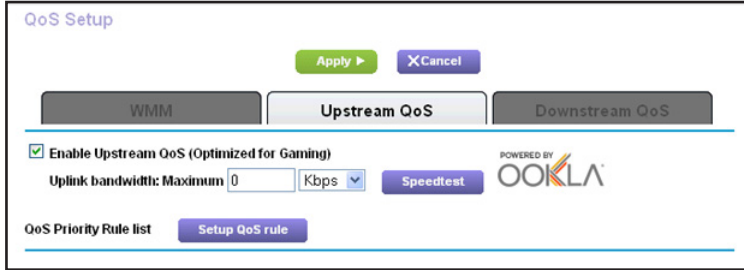

5. Click the **Setup QoS Rule** button.  
The QoS Priority Rule list displays.
6. Select the radio button for the QoS policy.
7. Scroll down and click the **Edit** button.
8. Change the policy settings.
9. Click the **Apply** button.  
Your changes are saved.

## Delete an Upstream QoS Policy

### ➤ To delete a QoS policy:

1. Launch an Internet browser from a computer or wireless device that is connected to the network.
2. Type <http://www.routerlogin.net> or <http://www.routerlogin.com>.  
A login screen displays.
3. Enter the router user name and password.  
The user name is **admin**. The default password is **password**. The user name and password are case-sensitive.  
The BASIC Home screen displays.
4. Select **ADVANCED > Setup > QoS Setup > Upstream QoS**.

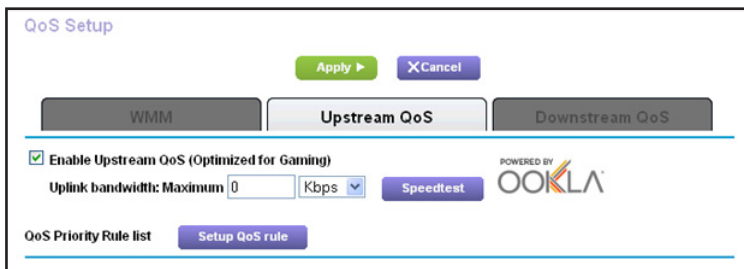

5. Click the **Setup QoS Rule** button.  
The QoS Priority Rule list displays.

6. Select the radio button for the QoS policy.
7. Click the **Delete** button.

The QoS Policy is removed from the list.

## Optimize Video Streaming with Downstream QoS

Downstream Quality of Service (QoS) assigns a high priority to Internet video streaming from websites like YouTube and Netflix.

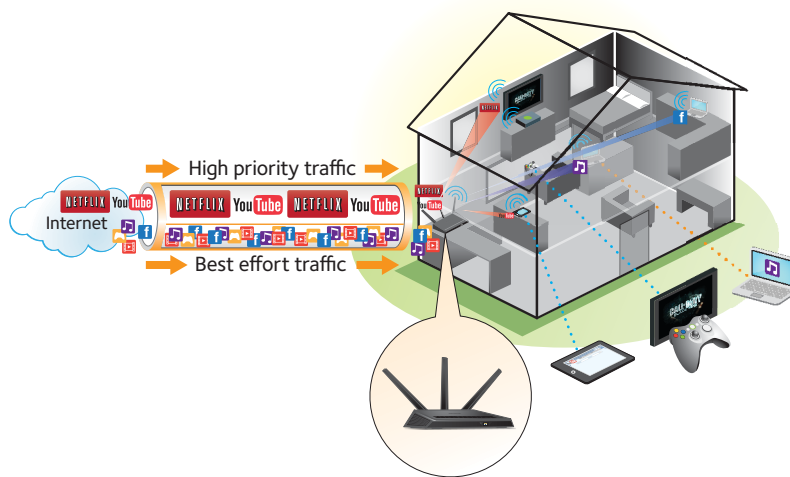

**Figure 8. Downstream QoS assigns a high priority to video streaming from the Internet**

NETGEAR recommends that you enable downstream QoS only if you watch streaming Internet video. When downstream QoS assigns a high priority to streaming video, it also assigns a lower priority to the rest of your Internet traffic. That means other tasks like downloading content from the Internet take longer.

### ➤ To enable downstream QoS:

1. Launch an Internet browser from a computer or wireless device that is connected to the network.
2. Type <http://www.routerlogin.net> or <http://www.routerlogin.com>.  
A login screen displays.
3. Enter the router user name and password.

The user name is **admin**. The default password is **password**. The user name and password are case-sensitive.

The BASIC Home screen displays.

4. Select **ADVANCED > Setup > QoS Setup > Downstream QoS**.



5. Select the **Enable Downstream QoS (Improved Video Streaming)** check box.

6. (Optional) Select the **Streaming Database Auto Upgrade** check box.

The router automatically checks for updates for the streaming database, and downloads and installs them.

7. Click the **Apply** button.

The router assigns a high priority to video streaming from the Internet traffic.

## Add Downstream QoS Rules by Keyword

➤ **To add a downstream QoS rule by keyword:**

1. Launch an Internet browser from a computer or wireless device that is connected to the network.

2. Type **http://www.routerlogin.net** or **http://www.routerlogin.com**.

A login screen displays.

3. Enter the router user name and password.

The user name is **admin**. The default password is **password**. The user name and password are case-sensitive.

The BASIC Home screen displays.

4. Select **ADVANCED > Setup > QoS Setup > Downstream QoS**.

5. Select the **Enable Downstream QoS (Improved Video Streaming)** check box.
6. In the Add Rules section, leave the **by Keyword** radio button selected.
7. In the **Rule Name** field, type the name of the rule.
8. In the **Keyword** field, type a keyword.
9. Click the **Add** button.

The rule is added to the QoS rules. The router assigns a high priority to Internet traffic from the server that matches the keyword.

## Add a Downstream QoS Rule by Device

### ➤ To add a downstream QoS rule by keyword:

1. Launch an Internet browser from a computer or wireless device that is connected to the network.
2. Type **http://www.routerlogin.net** or **http://www.routerlogin.com**.

A login screen displays.

3. Enter the router user name and password.

The user name is **admin**. The default password is **password**. The user name and password are case-sensitive.

The BASIC Home screen displays.

4. Select **ADVANCED > Setup > QoS Setup > Downstream QoS**.

5. Select the **Enable Downstream QoS (Improved Video Streaming)** check box.

6. In the Add Rules section, select the **by Device** radio button.

The screen adjusts.

7. In the **MAC Device** list, select a radio button for a device.

8. Click the **Add** button.

The router assigns a high priority to streaming traffic that goes from the Internet to the device you specified.

## Improve Network Connections with Universal Plug and Play

Universal Plug and Play (UPnP) helps devices, such as Internet appliances and computers, access the network and connect to other devices as needed. UPnP devices can automatically discover the services from other registered UPnP devices on the network.

If you use applications such as multiplayer gaming, peer-to-peer connections, or real-time communications such as instant messaging or remote assistance (a feature in Windows XP), enable UPnP.

➤ **To enable Universal Plug and Play:**

1. Launch an Internet browser from a computer or wireless device that is connected to the network.
2. Type <http://www.routerlogin.net> or <http://www.routerlogin.com>.

A login screen displays.

3. Enter the router user name and password.

The user name is **admin**. The default password is **password**. The user name and password are case-sensitive.

The BASIC Home screen displays.

4. Select **ADVANCED > Advanced Setup > UPnP**.

The UPnP screen displays.

5. Select the **Turn UPnP On** check box.

By default, this check box is selected. UPnP for automatic device configuration can be enabled or disabled. If the **Turn UPnP On** check box is cleared, the router does not allow any device to automatically control router resources, such as port forwarding.

6. Type the advertisement period in minutes.

The advertisement period specifies how often the router broadcasts its UPnP information. This value can range from 1 to 1440 minutes. The default period is 30 minutes. Shorter durations ensure that control points provide current device status at the expense of more network traffic. Longer durations can compromise the freshness of the device status, but can significantly reduce network traffic.

7. Type the advertisement time to live in hops.

The time to live for the advertisement is measured in hops (steps) for each UPnP packet sent. Hops are the steps a packet takes between routers. The number of hops can range from 1 to 255. The default value for the advertisement time to live is **4** hops, which is fine for most home networks. If you notice that some devices are not being updated or reached correctly, it might be necessary to increase this value.

8. Click the **Apply** button.

The UPnP Portmap Table displays the IP address of each UPnP device that is accessing the router and which ports (internal and external) that device opened. The UPnP Portmap Table also displays what type of port is open and whether that port is still active for each IP address.

To refresh the information in the UPnP Portmap Table, click the **Refresh** button.

## Wi-Fi Multimedia Quality of Service

Wi-Fi Multimedia Quality of Service (WMM QoS) prioritizes wireless voice and video traffic over the WiFi link. WMM QoS is automatically enabled for the router.

WMM QoS prioritizes wireless data packets from different applications based on four access categories: voice, video, best effort, and background. For an application to receive the benefits of WMM QoS, WMM must be enabled for both it and the client running that application. Legacy applications that do not support WMM and applications that do not require QoS are assigned to the best effort category, which receives a lower priority than voice and video.

➤ **To disable WMM QoS:**

1. Launch an Internet browser from a computer or wireless device that is connected to the network.
2. Type **http://www.routerlogin.net** or **http://www.routerlogin.com**.  
A login screen displays.
3. Enter the router user name and password.  
The user name is **admin**. The default password is **password**. The user name and password are case-sensitive.  
The BASIC Home screen displays.
4. Select **ADVANCED > Setup > QoS Setup**.  
The QoS Setup screen displays.
5. Clear the **Enable WMM (Wi-Fi multimedia) settings (2.4 GHz b/g/n)** check box.
6. Clear the **Enable WMM (Wi-Fi multimedia) settings (5 GHz b/g/n)** check box.
7. Click the **Apply** button.  
Your changes are saved.

# Control Access to the Internet

---

# 5

The router comes with a built-in firewall that helps protect your home network from unwanted intrusions from the Internet.

This chapter includes the following sections:

- *Set Up Parental Controls*
- *Control Access to Your Network*
- *Use Keywords to Block Internet Sites*
- *Block Services from the Internet*
- *Schedule When to Block Internet Sites and Services*
- *Avoid Blocking on a Trusted Computer*
- *Set Up Security Event Email Notifications*



## Set Up Parental Controls

The first time that you select **Parental Controls** from the BASIC Home screen, your browser goes to the Live Parental Controls website, where you can learn more about Live Parental Controls and download the application.

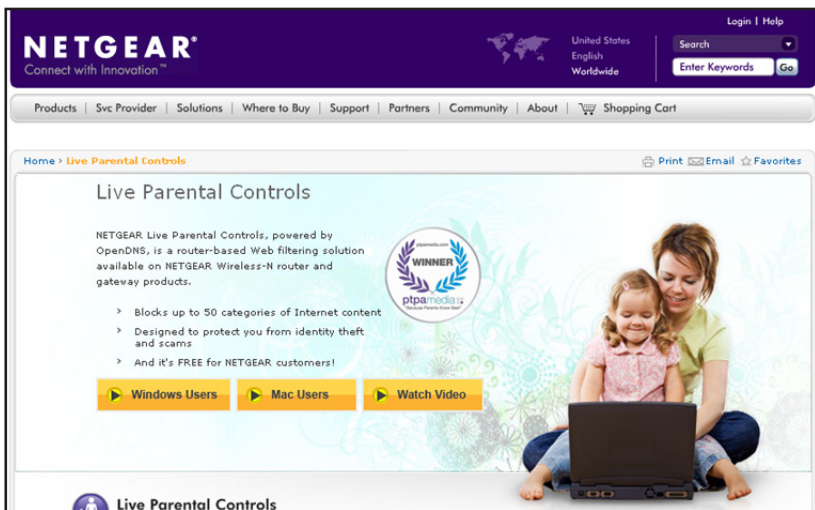

### ➤ To set up Live Parental Controls:

1. Launch an Internet browser from a computer or wireless device that is connected to the network.
2. Type <http://www.routerlogin.net> or <http://www.routerlogin.com>.  
A login screen displays.
3. Enter the router user name and password.  
The user name is **admin**. The default password is **password**. The user name and password are case-sensitive.  
The BASIC Home screen displays.
4. Select **Parental Controls**.  
If your Internet connection is working, the browser automatically goes online and displays the Parental Controls web page.
5. Click either the **Windows Users** or **Mac Users** button.
6. Follow the onscreen instructions to download and install the NETGEAR Live Parental Controls management utility.

After installation, Live Parental Controls automatically starts.

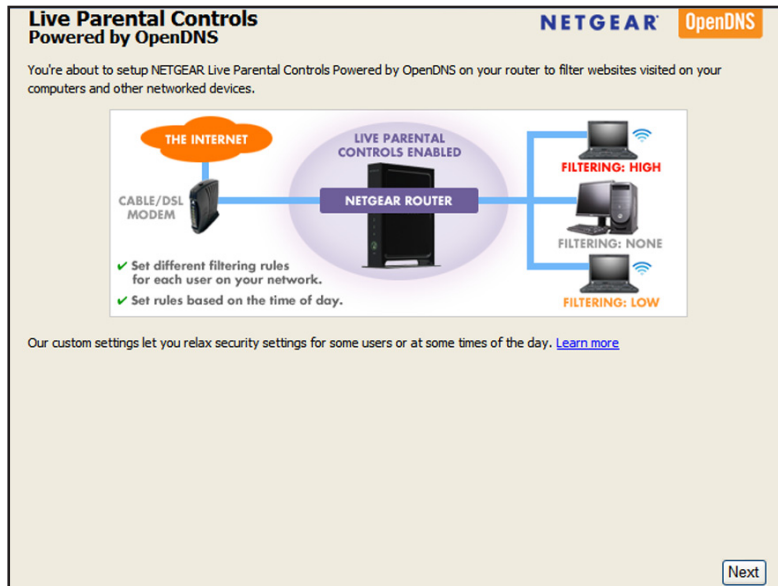

7. Click the **Next** button.
8. Read the note, and click the **Next** button again.

Because Live Parental Controls uses free OpenDNS accounts, you are prompted to log in or create a free account.

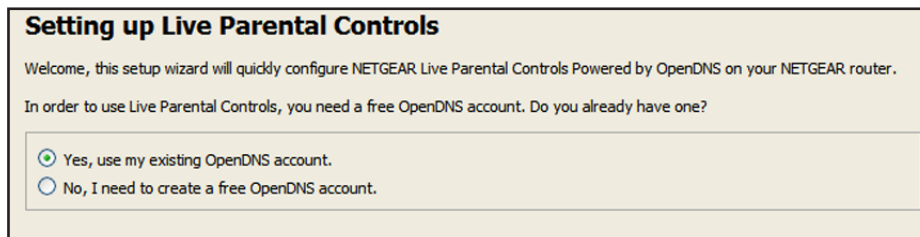

9. Select the radio button that applies to you:
  - If you already set up an OpenDNS account, leave the **Yes** radio button selected.
  - If you did not set up an OpenDNS account, select the **No** radio button.
10. Click the **Next** button.

If you are creating an account, the following screen displays:

11. Complete the fields and click the **Next** button.

After you log on or create your account, the filtering level screen displays:

**Live Parental Controls: choose a filtering level for your network**

All computers connected to your router will be protected from the content you select below. You can customize your Live Parental Controls later on our website.

**High**  
Protects against all adult-related sites, illegal activity, social networking sites, video sharing sites, phishing attacks and general time-wasters.

**Moderate**  
Protects against all adult-related sites, illegal activity and phishing attacks.

**Low**  
Protects against pornography and phishing attacks.

**Minimal**  
Protects only against phishing attacks.

**None**  
Nothing blocked.

12. Select a radio button for a filtering level and click the **Next** button.

**Setup is complete!**

You have successfully setup NETGEAR Live Parental Controls Powered by OpenDNS. Next time you run the Management Utility it will take you to the status screen where you can:

- check whether Live Parental Controls are enabled
- disable or enable Live Parental Controls
- modify basic settings
- change custom settings such as per-user and time-of-day based Live Parental Controls

[Take me to the status screen](#)

13. Click the **Take me to the status screen** button.

Parental controls are now set up for the router. The dashboard shows Parental Controls as Enabled.

## Control Access to Your Network

You can use access control to allow or block access to your network.

➤ **To set up access control:**

1. Launch an Internet browser from a computer or wireless device that is connected to the network.
2. Type <http://www.routerlogin.net> or <http://www.routerlogin.com>.  
A login screen displays.
3. Enter the router user name and password.

The user name is **admin**. The default password is **password**. The user name and password are case-sensitive.

The BASIC Home screen displays.

4. Select **ADVANCED > Security > Access Control**.

The Access Control screen displays.

5. Select the **Turn on Access Control** check box.

You must select this check box before you can specify an access rule and use the Allow and Block buttons. When this check box is cleared, all devices are allowed to connect, even if the device is in the blocked list.

6. Select an access rule:

- **Allow all new devices to connect.** With this setting, if you buy a new device, it can access your network. You don't need to enter its MAC address in this screen. NETGEAR recommends that you leave this radio button selected.
- **Block all new devices from connecting.** With this setting, if you buy a new device, before it can access your network, you must enter its MAC address for an Ethernet connection and its MAC address for a WiFi connection in the allowed list.

The access rule does not affect previously blocked or allowed devices. It applies only to devices joining your network in the future after you apply these settings.

7. To allow the computer or device you're currently using to continue to access the network, select the check box next to your computer or device, and click the **Allow** button.
8. Click the **Apply** button.

Your changes take effect.

## Use Keywords to Block Internet Sites

You can use keywords to block certain Internet sites from your network. You can use blocking continuously or based on a schedule.

### ➤ To block Internet sites:

1. Launch an Internet browser from a computer or wireless device that is connected to the network.
2. Type **http://www.routerlogin.net** or **http://www.routerlogin.com**.  
A login screen displays.
3. Enter the router user name and password.

The user name is **admin**. The default password is **password**. The user name and password are case-sensitive.

The BASIC Home screen displays.

4. Select **ADVANCED > Security > Block Sites**.

5. Select a keyword blocking option:

- **Per Schedule.** Turn on keyword blocking according to a schedule that you set. (See [Schedule When to Block Internet Sites and Services](#) on page 64.)
- **Always.** Turn on keyword blocking all the time, independent of the Schedule screen.

6. In the **keyword** field, enter a keyword or domain that you want to block.

For example:

- Specify XXX to block <http://www.badstuff.com/xxx.html>.
- Specify .com if you want to allow only sites with domain suffixes such as .edu or .gov.
- Enter a period (.) to block all Internet browsing access.

7. Click the **Add Keyword** button.

The keyword is added to the keyword list. The keyword list supports up to 32 entries.

8. Click the **Apply** button.

Keyword blocking takes effect.

## Delete Keywords from the List to Be Blocked

➤ **To delete keywords from the list:**

1. Launch an Internet browser from a computer or wireless device that is connected to the network.
2. Type <http://www.routerlogin.net> or <http://www.routerlogin.com>.  
A login screen displays.
3. Enter the router user name and password.

The user name is **admin**. The default password is **password**. The user name and password are case-sensitive.

The BASIC Home screen displays.

4. Select **ADVANCED > Security > Block Sites**.

5. Do one of the following:

- To delete a single word, select it and click the **Delete Keyword** button.  
The keyword is removed from the list.
- To delete all keywords on the list, click the **Clear List** button.  
All keywords are removed from the list.

6. Click the **Apply** button.

Your changes are saved.

## Block Services from the Internet

You can block Internet services on your network based on the type of service. You can block the services all the time or based on a schedule.

➤ **To block services:**

1. Launch an Internet browser from a computer or wireless device that is connected to the network.
2. Type **http://www.routerlogin.net** or **http://www.routerlogin.com**.  
A login screen displays.
3. Enter the router user name and password.

The user name is **admin**. The default password is **password**. The user name and password are case-sensitive.

The BASIC Home screen displays.

4. Select **ADVANCED > Security > Block Services**.

The Block Services screen displays.

5. Specify when to block the services:

- To block the services all the time, select the **Always** radio button.
- To block the services based on a schedule, select the **Per Schedule** radio button.

For more information about how to specify the schedule, see [Schedule When to Block Internet Sites and Services](#) on page 64.

6. Click the **Add** button.

The Block Services Setup screen displays:

7. To add a service that is in the **Service Type** list, select the application or service.

The settings for this service automatically display in the fields.

8. To add a service or application that is not the list, select **User Defined** and do the following.

- a. If you know that the application uses either TCP or UDP, select the appropriate protocol; otherwise, select **TCP/UDP** (both).
- b. Enter the starting port and ending port numbers.

If the service uses a single port number, enter that number in both fields.

To find out which port numbers the service or application uses, you can contact the publisher of the application, ask user groups or newsgroups, or search on the Internet.

9. Select a filtering option:

- **Only This IP Address**. Block services for a single computer.
- **IP Address Range**. Block services for a range of computers with consecutive IP addresses on your network.
- **All IP Addresses**. Block services for all computers on your network.

10. Click the **Add** button.

Your changes are saved.

## Schedule When to Block Internet Sites and Services

When you schedule blocking, the same schedule is used to block sites and to block services. For information about how to specify what you want the router to block, see [Use Keywords to Block Internet Sites](#) on page 60 and [Block Services from the Internet](#) on page 62.

### ➤ To schedule blocking:

1. Launch an Internet browser from a computer or wireless device that is connected to the network.
2. Type <http://www.routerlogin.net> or <http://www.routerlogin.com>.  
A login screen displays.
3. Enter the router user name and password.  
The user name is **admin**. The default password is **password**. The user name and password are case-sensitive.  
The BASIC Home screen displays.
4. Select **ADVANCED > Security > Schedule**.  
The Schedule screen displays.
5. Specify when to block keywords and services:
  - **Days to Block**. Select the check box for each day that you want to block the keywords or select the **Every Day** check box, which automatically selects the check boxes for all days.
  - **Time of Day to Block**. Select a start and end time in 24-hour format or select **All Day** for 24-hour blocking.
6. Select your time zone from the list.
7. If you live in a region that observes daylight saving time, select the **Automatically adjust for daylight savings time** check box.
8. Click the **Apply** button.  
Your settings are saved.

## Avoid Blocking on a Trusted Computer

You can exempt one trusted computer from blocking. The computer you exempt must use a fixed IP address. You can use the reserved IP address feature to specify the IP address. See [Reserve LAN IP Addresses](#) on page 111.

### ➤ To specify a trusted computer:

1. Launch an Internet browser from a computer or wireless device that is connected to the network.
2. Type <http://www.routerlogin.net> or <http://www.routerlogin.com>.



A login screen displays.

3. Enter the router user name and password.

The user name is **admin**. The default password is **password**. The user name and password are case-sensitive.

The BASIC Home screen displays.

4. Select **ADVANCED > Security > Block Sites**.

The Block Sites screen displays.

5. Scroll down and select the **Allow trusted IP address to visit blocked sites** check box.

6. In the **Trusted IP Address** field, enter the IP address of the trusted computer.

7. Click the **Apply** button.

Your changes are saved.

## Set Up Security Event Email Notifications

The router can email you its logs of router activity. The log records router activity and security events such as attempts to access blocked sites or services.

### ➤ To set up email notifications:

1. Launch an Internet browser from a computer or wireless device that is connected to the network.

2. Type **http://www.routerlogin.net** or **http://www.routerlogin.com**.

A login screen displays.

3. Enter the router user name and password.

The user name is **admin**. The default password is **password**. The user name and password are case-sensitive.

The BASIC Home screen displays.

4. Select **ADVANCED > Security > E-mail**.

5. Select the **Turn E-mail Notification On** check box.
6. In the **Your Outgoing Mail Server** field, enter the name of your ISP outgoing (SMTP) mail server (such as mail.myISP.com).  
  
You might be able to find this information in the configuration screen of your email program. If you leave this field blank, log and alert messages are not sent.
7. In the **Send to This E-mail Address** field, type the email address to which logs and alerts are sent.  
  
This email address is also used for the **From** address. If this field is blank, log and alert messages are not sent.
8. If your outgoing email server requires authentication, select the **My Mail Server requires authentication** check box and do the following.
  - a. In the **User Name** field, type the user name for the outgoing email server.
  - b. In the **Password** field, type the password for the outgoing email server.
9. To have email alerts sent immediately when someone attempts to visit a blocked site, select the **Send Alerts Immediately** check box.
10. To send logs based on a schedule, specify these settings:
  - From **Send logs according to this schedule** list, select the schedule type.
  - From the **Day** list, select the day.
  - From the **Time** list, select the time, and select the **am** or **pm** radio button.
11. Click the **Apply** button.

Your settings are saved.

Logs are sent automatically according to the schedule you set. If the log fills before the specified time, it is sent. After the log is sent, it is cleared from the router memory. If the router cannot email the log and the log buffer fills, the router overwrites the log.

# Share USB Drives Attached to the Router

---

# 6

This chapter describes how to access and configure USB storage devices attached to your router. The USB port on the router can be used only to connect USB storage devices like flash drives or hard drives or a printer. Do not connect computers, USB modems, CD drives, or DVD drives to the router USB port.

This chapter contains the following sections:

- *USB Drive Requirements*
- *Access a USB Device on the Network*
- *Back Up Windows Computers with ReadySHARE Vault*
- *Back Up Mac Computers with Time Machine*
- *Control Access to the USB Drive*
- *Use FTP Within the Network*
- *View Network Folders on a USB Drive*
- *Add a Network Folder on a USB Drive*
- *Edit a Network Folder on a USB Drive*
- *Approve USB Devices*
- *Safely Remove a USB Drive*

For more information about ReadySHARE features, visit [www.netgear.com/readyshare](http://www.netgear.com/readyshare).

## USB Drive Requirements

The router works with most USB-compliant external flash and hard drives. For the most up-to-date list of USB drives that the router supports, visit

<http://kbserver.netgear.com/readystatechange>.

Some USB external hard drives and flash drives require you to load the drivers onto the computer before the computer can access the USB device. Such USB devices do not work with the router.

The router supports the following file system types for full read/write access:

- FAT16
- FAT32
- NTFS
- NTFS with compression format enabled
- EXT2
- EXT3
- EXT4
- XFS
- HFS
- HFS+

## Access a USB Device on the Network

ReadySHARE lets you access and share a USB device connected to the router USB port. (If your USB drive uses special drivers, it is not compatible.)

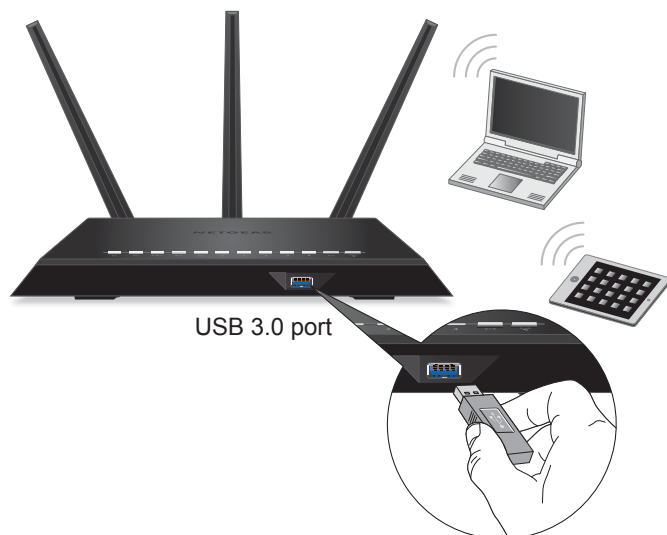

**Figure 9.** The blue USB 3.0 port on the front of the router provides the fastest access

➤ **To connect a USB device:**

1. Insert your USB storage device into the blue USB 3.0 port on the front of the router.
2. If your USB device uses a power supply, connect it.

You must use it when you connect the USB device to the router.

When you connect the USB device to the router USB port, it might take up to two minutes before it is ready for sharing. By default, the USB device is available to all computers on your local area network (LAN).

➤ **To access the USB device from a Mac:**

1. Select **Go > Connect to Server**.
2. Enter **smb://readyshare** as the server address.
3. Click the **Connect** button.
4. When prompted, select the **Guest** radio button.

If you set up access control and you allowed your Mac to access the network, select the **Registered User** radio button and enter **admin** for the name and **password** for the password. For more information about access control, see [Control Access to Your Network](#) on page 59.

5. Click the **Connect** button.

The USB device displays.

➤ **To access the USB device from a Windows computer:**

1. Select **Start > Run**.
2. Enter **\\readyshare** in the dialog box.
3. Click the **OK** button.

The USB device displays.

➤ **To map the USB device to a Windows network drive:**

1. Visit [www.netgear.com/readyshare](http://www.netgear.com/readyshare).
2. In the ReadySHARE USB Storage Access pane, click the **PC Utility** link.

The `readyshareconnect.exe` file is downloaded to your computer.

3. Launch `readyshareconnect.exe`.

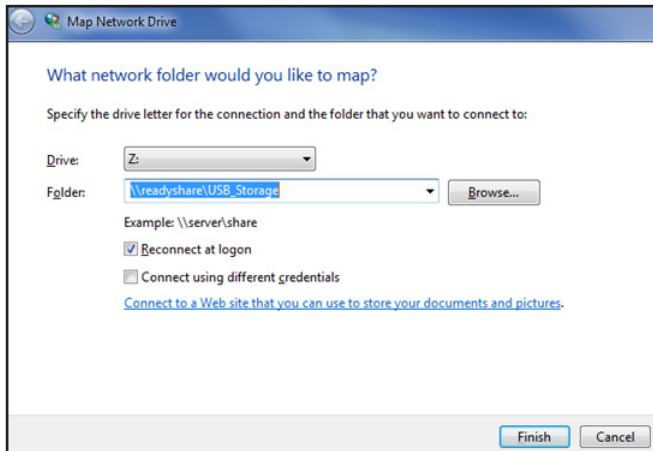

4. Select the drive letter to map to the network folder.
5. To connect to the USB drive as a different user, select the **Connect using different credentials** check box and do the following:
  - a. Type the user name and password.
  - b. Click the **OK** button.
6. Click the **Finish** button.

The USB drive is mapped to the drive letter that you specified.

## Back Up Windows Computers with ReadySHARE Vault

Your router comes with free backup software for all the Windows computers in your home. Connect a USB hard disk drive (HDD) to the USB port on your router for centralized, continuous, and automatic backup.

### ➤ To back up your Windows computer:

1. Insert your USB storage device into the blue USB 3.0 port on the front of the router.  
If your USB device uses a power supply, connect it.

You must use it when you connect the USB device to the router.

When you connect the USB device to the router USB port, it might take up to two minutes before it is ready for sharing. By default, the USB device is available to all computers on your local area network (LAN).

2. Install the genie app on each Windows computer.  
To download the genie app, visit [www.netgear.com/genie](http://www.netgear.com/genie).
3. Download ReadySHARE Vault from [www.netgear.com/readyshare](http://www.netgear.com/readyshare) and install it on each Windows computer.
4. Launch ReadySHARE Vault.

5. Use the dashboard or the **Backup** tab to set up and run your backup.

## Back Up Mac Computers with Time Machine

You can use Time Machine to back up your Mac computers onto a USB hard drive that is connected to one of the router's USB ports. You can access the connected USB hard drive from your Mac with a wired or wireless connection to your router.

### Set Up a USB Hard Drive on a Mac

NETGEAR recommends that you use a new USB HDD or format your old USB disk to do the Time Machine backup for the first time. Use a blank partition to prevent some issues during backup using Time Machine. The router supports GUID or MBR partitions.

- **To format your USB hard disk drive and specify partitions:**
  1. Physically connect the USB hard drive to your Mac.
  2. On your Mac, go to **Spotlight** (or the magnifying glass) at the top right of the screen and search for **Disk Utility**.
  3. To format your USB drive, open the Disk Utility, click the **Erase** tab, and click the **Erase** button.
  4. Click the **Partition** tab.
  5. Click **Partition Layout** and set the number of partitions that you want to use.
  6. Click the **Options** button.  
The Partition options display.
  7. Select the **GUID Partition Table** or **Master Boot Record** radio button.
  8. For the format, select **Mac OS Extended (Journaled)**.
  9. Click the **OK** button.
  10. Click the **Apply** button.  
Your settings are saved.

### Prepare to Back Up a Large Amount of Data

Before you back up a large amount of data with Time Machine, NETGEAR recommends that you follow this procedure.

- **To prepare to back up a large amount of data:**
  1. Upgrade the operating system of the Mac computer.
  2. Verify and repair the backup disk and the local disk.
  3. Verify and repair the permissions on the local disk.
  4. Set Energy Saver:

- a. From the **Apple** menu, select **System Preferences**.
- b. From the **View** menu, select **Energy Saver**.
- c. Click the **Power Adapter** tab.
- d. Select the **Wake for Wi-Fi network access** check box.
- e. Click the **Back arrow** to save the changes and exit the screen.
5. Modify your security settings:
  - a. From the **Apple** menu, select **System Preferences**.
  - b. From the **View** menu, select **Security**.
  - c. Click the **Advanced** button at the bottom of the screen.
  - d. Leave the **Log out after minutes of inactivity** check box cleared.

## Use Time Machine to Back Up onto a USB Hard Drive

You can use Time Machine to back up your Mac computers onto a USB hard disk drive that is connected to one of the router's USB ports.

### ➤ To back up your Mac onto a USB hard drive:

1. Prepare your USB drive with a compatible format and partitions.

See *Set Up a USB Hard Drive on a Mac* on page 71.

If you plan to back up a large amount of data, see *Prepare to Back Up a Large Amount of Data* on page 71.

2. Insert your USB storage drive into a USB port on the router.

**Note:** If your USB drive includes a power supply, you must use it when you connect the USB drive to the router.

The blue USB 3.0 port on the front of the router performs faster than the USB 2.0 port on the rear panel of the router.

When you connect the USB drive to the router USB port, it might take up to two minutes before it is ready for sharing. By default, the USB drive is available to all computers on your local area network (LAN).

3. On your Mac computer, select **Go > Connect to Server**.
4. Type **afp://routerlogin.net**.
5. When prompted to enter your name and password, select the **Guest** radio button.
6. Click the **Connect** button.

A list of connected devices displays. This list includes the name admin when you log in as admin.

7. From the **Apple** menu, select **System Preferences**.
8. Open Time Machine.



9. Click the **Select Backup Disk** button and select your USB drive from the list.
10. Click the **Use for Backup** button.

**Note:** If you do not see the USB partition that you want in the Time Machine disk list, go to Mac finder and click that USB partition. It displays in the Time Machine list.

11. When prompted to enter your name and password, select the **Guest** radio button and click the **Connect** button.

When the setup is complete, the Mac automatically schedules a full back up. You can back up immediately if you want.

## Control Access to the USB Drive

You can specify the device name, workgroups, and network folders for your USB device.

### ➤ To specify the USB access settings:

1. Launch an Internet browser from a computer or wireless device that is connected to the network.
2. Type <http://www.routerlogin.net> or <http://www.routerlogin.com>.

A login screen displays.

3. Enter the router user name and password.

The user name is **admin**. The default password is **password**. The user name and password are case-sensitive.

The BASIC Home screen displays.

4. Select **ADVANCED > USB Storage > Advanced Settings**.

USB Storage (Advanced Settings)

---

Network Device Name :

Workgroup :

Enable	Access Method	Link	Port
<input checked="" type="checkbox"/>	Network Connection	\\readyshare	-
<input checked="" type="checkbox"/>	HTTP	<a href="http://readyshare.routerlogin.net/shares">http://readyshare.routerlogin.net/shares</a>	80
<input type="checkbox"/>	HTTPS (via internet)	https://0.0.0.0/shares	443
<input type="checkbox"/>	FTP	<a href="ftp://readyshare.routerlogin.net/shares">ftp://readyshare.routerlogin.net/shares</a>	21
<input type="checkbox"/>	FTP (via internet)	ftp://0.0.0.0/shares	21

---

Available Network Folders

	Share Name	Read Access	Write Access	Folder Name	Volume Name	Total Space	Free Space
<input checked="" type="checkbox"/>	\\readyshare\USB_Storage	All - no password	All - no password	U:\	HP v100w	1.9G	914.5M

---

5. Specify access to the USB storage device:
  - **Network Device Name.** This is the name used to access the USB device connected to the router. The default is readyshare.
  - **Workgroup.** If you are using a Windows workgroup rather than a domain, the workgroup name is displayed here. The name works only in an operating system that supports NetBIOS, such as Microsoft Windows.
  - **Access Method.** Select the check boxes for the access methods that you want:
    - **Network Neighborhood/MacShare.** Enabled by default.
    - **HTTP.** Enabled by default. You can type **http://readyshare.routerlogin.net/shares** to access the USB drive.
    - **HTTP (via Internet).** Disabled by default. If you enable this feature, remote users can type **http://<public IP address/shares>** (for example, **http://1.1.10.102/shares**) or a URL domain name to access the USB drive over the Internet. This feature supports file uploading only.
    - **FTP.** Disabled by default.
    - **FTP (via Internet).** Disabled by default. If you select this check box, remote users can access the USB drive through FTP over the Internet. This feature supports both downloading and uploading of files.
6. If you changed the settings, click the **Apply** button.

Your changes are saved.

## Use FTP Within the Network

File Transfer Protocol (FTP) lets you send and receive large files faster.

### ➤ To set up FTP access:

1. Launch an Internet browser from a computer or wireless device that is connected to the network.
2. Type **http://www.routerlogin.net** or **http://www.routerlogin.com**.

A login screen displays.

3. Enter the router user name and password.

The user name is **admin**. The default password is **password**. The user name and password are case-sensitive.

The BASIC Home screen displays.

4. Select **ADVANCED > USB Storage > Advanced Settings**.

USB Storage (Advanced Settings)

Apply Refresh

Network Device Name: readyshare

Workgroup: Workgroup

Enable	Access Method	Link	Port
<input checked="" type="checkbox"/>	Network Connection	\\readyshare	-
<input checked="" type="checkbox"/>	HTTP	<a href="http://readyshare.routerlogin.net/shares">http://readyshare.routerlogin.net/shares</a>	80
<input type="checkbox"/>	HTTPS (via internet)	<a href="https://0.0.0.0/shares">https://0.0.0.0/shares</a>	443
<input checked="" type="checkbox"/>	FTP	<a href="ftp://readyshare.routerlogin.net/shares">ftp://readyshare.routerlogin.net/shares</a>	21
<input type="checkbox"/>	FTP (via internet)	<a href="ftp://0.0.0.0/shares">ftp://0.0.0.0/shares</a>	21

Available Network Folders

	Share Name	Read Access	Write Access	Folder Name	Volume Name	Total Space	Free Space
<input checked="" type="checkbox"/>	\\readyshare\USB_Storage	All - no password	All - no password	U:\	HP v100w	1.9G	914.5M

Edit Create Network Folder Delete

Help Center Show/Hide Help Center

5. Select the **FTP** check box.

6. Click the **Apply** button.

Your changes are saved.

## View Network Folders on a USB Drive

You can view or change the network folders on the USB storage device.

➤ **To view or change network folders:**

1. Launch an Internet browser from a computer or wireless device that is connected to the network.

2. Type **http://www.routerlogin.net** or **http://www.routerlogin.com**.

A login screen displays.

3. Enter the router user name and password.

The user name is **admin**. The default password is **password**. The user name and password are case-sensitive.

The BASIC Home screen displays.

4. Select **ADVANCED > USB Storage > Advanced Settings**.

USB Storage (Advanced Settings)

Apply ▶ Refresh

Network Device Name :

Workgroup :

Enable	Access Method	Link	Port
<input checked="" type="checkbox"/>	Network Connection	\\readystatechange	-
<input checked="" type="checkbox"/>	HTTP	<a href="http://readystatechange.routerlogin.net/shares">http://readystatechange.routerlogin.net/shares</a>	80
<input type="checkbox"/>	HTTPS (via internet)	<a href="https://0.0.0.0/shares">https://0.0.0.0/shares</a>	443
<input type="checkbox"/>	FTP	<a href="ftp://readystatechange.routerlogin.net/shares">ftp://readystatechange.routerlogin.net/shares</a>	21
<input type="checkbox"/>	FTP (via internet)	<a href="ftp://0.0.0.0/shares">ftp://0.0.0.0/shares</a>	21

Available Network Folders

	Share Name	Read Access	Write Access	Folder Name	Volume Name	Total Space	Free Space
<input checked="" type="radio"/>	\\readystatechange\USB_Storage	All - no password	All - no password	U:\	HP v100w	1.9G	914.5M

Edit Create Network Folder Delete

Safely Remove USB Device

## 5. Scroll down to the Available Networks Folder section, and adjust the following settings:

- **Share Name.** If only one device is connected, the default share name is USB\_Storage. (Some router models include more than one USB port.)

You can click the name, or you can type it in the address field of your web browser. If Not Shared is shown, the default share was deleted, and no other share for the root folder exists. Click the link to change this setting.

- **Read Access and Write Access.** Show the permissions and access controls on the network folder. All–no password (the default) allows all users to access the network folder. The password for admin is the same one that you use to log in to the router.
- **Folder Name.** Full path of the network folder.
- **Volume Name.** Volume name from the storage device (either USB drive or HDD).
- **Total Space and Free Space.** Show the current utilization of the storage device.

## Add a Network Folder on a USB Drive

You can edit network folders on the USB storage device.

### ➤ To add a network folder:

1. Launch an Internet browser from a computer or wireless device that is connected to the network.
2. Type <http://www.routerlogin.net> or <http://www.routerlogin.com>.

A login screen displays.

3. Enter the router user name and password.

The user name is **admin**. The default password is **password**. The user name and password are case-sensitive.

The BASIC Home screen displays.

4. Select **ADVANCED > USB Storage > Advanced Settings**.

The USB Storage (Advanced Settings) screen displays.

5. Click the **Create Network Folder** button.

USB Device	U: (HP v100w) ▾
Folder	U:\Photos\ <input type="button" value="Browse"/>
Share Name	Vacation Photos
Read Access	All - no password ▾
Write Access	All - no password ▾
<input type="button" value="Apply"/>	
<input type="button" value="Close Window"/>	

If this screen does not display, your web browser might be blocking pop-ups. If it is, change the browser settings to allow pop-ups.

6. In the **USB Device** list, select the USB drive.
7. Click the **Browse** button and in the **Folder** field, select the folder.
8. In the **Share Name** field, type the name of the share.
9. In the **Read Access** list and the **Write Access** list, select the settings that you want.

The user name (account name) for All–no password is guest. The password for admin is the same one that is used to log in to the router. By default, it is password.

10. Click the **Apply** button.

The folder is added on the USB device.

## Edit a Network Folder on a USB Drive

You can add network folders on the USB storage device.

### ➤ To edit a network folder:

1. Launch an Internet browser from a computer or wireless device that is connected to the network.
2. Type <http://www.routerlogin.net> or <http://www.routerlogin.com>.

A login screen displays.

3. Enter the router user name and password.

The user name is **admin**. The default password is **password**. The user name and password are case-sensitive.

The BASIC Home screen displays.

4. Select **ADVANCED > USB Storage > Advanced Settings**.

The USB Storage (Advanced Settings) screen displays.

5. Click the **Edit** button.

The Edit Network Folder screen displays the same settings shown in the Add a Network Folder screen.

6. Change the settings in the fields as needed.

7. Click the **Apply** button.

Your changes are saved.

## Approve USB Devices

For more security, you can set up the router to share only USB devices that you approve.

### ➤ To approve USB devices:

1. Launch an Internet browser from a computer or wireless device that is connected to the network.

2. Type **http://www.routerlogin.net** or **http://www.routerlogin.com**.

A login screen displays.

3. Enter the router user name and password.

The user name is **admin**. The default password is **password**. The user name and password are case-sensitive.

The BASIC Home screen displays.

4. Select **ADVANCED > Advanced Setup > USB Settings**.

By default the **Enable any USB Device connection to the USB port** radio button is selected. This setting lets you connect and access all your USB drives.

5. Select the **No** radio button.

- Click the **Approved Devices** button.

USB Drive Approved Devices

Apply Refresh

Allow only approved devices

Approved USB Devices

	Volume Name	Device Name	Capacity
	HP v100w	HP v100w	1.9GB

Delete

Available USB Devices

	Volume Name	Device Name	Capacity
	HP v100w	HP v100w	1.9GB

Add

The approved and available USB devices display.

- In the **Available USB Devices** list, select the drive that you want to approve.

- Click the **Add** button.

The USB device is added to the Approved USB Devices list.

- Select the **Allow only approved devices** check box.

- Click the **Apply** button.

Your change takes effect.

- To work with another USB device, first click the **Safely Remove USB Device** button for the currently connected USB device.

Connect the other USB device, and repeat this process.

## Safely Remove a USB Drive

Before you physically disconnect a USB drive from the router USB port, log in to the router and take the drive offline.

### ➤ To remove a USB disk drive safely:

- Launch an Internet browser from a computer or wireless device that is connected to the network.
- Type **http://www.routerlogin.net** or **http://www.routerlogin.com**.

A login screen displays.

- Enter the router user name and password.

The user name is **admin**. The default password is **password**. The user name and password are case-sensitive.

The BASIC Home screen displays.

4. Select **USB Storage > Basic Settings**.

The USB Settings screen displays.

5. Click the **Safely Remove USB Device** button.

This takes the drive offline.

6. Physically disconnect the USB drive.



# Access the Router's USB Drive Through the Internet

---

# 7

With Dynamic DNS, you can use the Internet to access a USB hard drive attached to the router's USB port router when you're not home. This chapter includes the following sections:

- *Access the USB Drive Through the Internet*
- *Dynamic DNS*
- *Your Personal FTP Server*
- *Set Up Your Personal FTP Server*

For information about how to connect the USB drive and specify its settings, see *Chapter 6, Share USB Drives Attached to the Router*.

## Access the USB Drive Through the Internet

You can access the USB drive through the Internet when you're not home.

➤ **To access the USB drive from a remote computer:**

1. Launch a web browser on a computer that is not on your home network.
2. Connect to your home router:

- To connect with Dynamic DNS, type the DNS name.

To use a Dynamic DNS account, you must enter the account information in the Dynamic DNS screen. See *Dynamic DNS* on page 84.

- To connect without Dynamic DNS, type the router's Internet port IP address.

You can view the router's Internet IP address on the BASIC Home screen.

You can use FTP to share files on a USB drive connected to the router.

## Set Up FTP Access Through the Internet

➤ **To set up FTP access:**

1. Launch an Internet browser from a computer or wireless device that is connected to the network.

2. Type **http://www.routerlogin.net** or **http://www.routerlogin.com**.

A login screen displays.

3. Enter the router user name and password.

The user name is **admin**. The default password is **password**. The user name and password are case-sensitive.

The BASIC Home screen displays.

4. Select **ADVANCED > USB Storage > Advanced Settings**.

USB Storage (Advanced Settings)

Apply Refresh

Network Device Name: readyshare

Workgroup: Workgroup

Enable	Access Method	Link	Port
<input checked="" type="checkbox"/>	Network Neighborhood/MacShare	\\readyshare	-
<input checked="" type="checkbox"/>	HTTP	http://readyshare.routerlogin.net/shares	80
<input type="checkbox"/>	HTTPS (via internet)	https://0.0.0.0/shares	443
<input type="checkbox"/>	FTP	ftp://readyshare.routerlogin.net/shares	21
<input checked="" type="checkbox"/>	FTP (via internet)	ftp://0.0.0.0/shares	21

Available Network Folders

	Share Name	Read Access	Write Access	Folder Name	Volume Name	Total Space	Free Space
<input checked="" type="radio"/>	readyshare\USB_Storage	All no password	All no password	U:\	HP v100w	1.9G	914.5M

Help Center Show/Hide Help Center

5. Select the **FTP (via Internet)** check box.
6. Click the **Apply** button.  
Your changes are saved.
7. To limit access to the admin user, click the **Edit** button.

Edit Network Folder

USB Device: U: (HP v100w)

File System: FAT

Folder: U:\ Browse

Share Name: USB\_Storage

Read Access: admin

Write Access: admin

Apply

8. In the **Read Access** list, select **admin**.
9. In the **Write Access** list, select **admin**.
10. Click the **Apply** button.

Your changes are saved.

## Access the USB Drive Through the Internet with FTP

You must first set up FTP through Internet access as described in *Set Up FTP Access Through the Internet* on page 82.

- To access the USB drive with FTP from a remote computer:
  1. Do one of the following:

- To download, launch an Internet browser.
  - To upload, use an FTP client such as filezilla.
2. Type **ftp://** and the Internet port IP address in the address field of the browser.  
For example, type **ftp://10.1.65.4**.
- If you are using Dynamic DNS, type the DNS name.  
For example, type **ftp://MyName.mynetgear.com**.
3. When prompted, log in:
- To log in as admin, in the **user name** field, type **admin** and in the **password** field, type the same password that you use to log in to the router.
  - To log in as guest, in the **user name** field, enter **guest**.
- The guest user name does not require a password. To restrict access to the USB drive, you can specify that only the admin user can access it. See [Control Access to the USB Drive](#) on page 73.
- The files and folders of the USB drive that your account can access displays. For example, you might see `share/partition1/directory1`.

## Dynamic DNS

Internet service providers (ISPs) assign numbers called IP addresses to identify each Internet account. Most ISPs use dynamically assigned IP addresses. This means that the IP address can change at any time. You can use the IP address to access your network remotely, but most people don't know what their IP addresses are or when this number changes.

To make it easier to connect, you can get a free account with a Dynamic DNS service that lets you use a domain name to access your home network. To use this account, you must set up the router to use Dynamic DNS. Then the router notifies the Dynamic DNS service provider whenever its IP address changes. When you access your Dynamic DNS account, the service finds the current IP address of your home network and automatically connects you.

If your ISP assigns a private WAN IP address (such as 192.168.x.x or 10.x.x.x), the Dynamic DNS service does not work because private addresses are not routed on the Internet.

## Your Personal FTP Server

With your customized free URL, you can use FTP to access your network when you aren't home through Dynamic DNS. To set up your FTP server, you must register for a free

NETGEAR Dynamic DNS (DDNS) service account and specify the account settings. See [Set Up a New Dynamic DNS Account](#) on page 85.

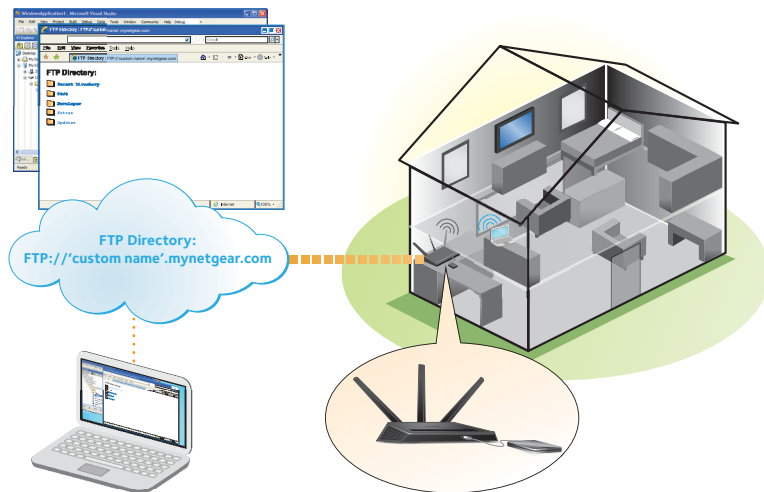

Figure 10. You can access your network through the Internet when you're not home

---

**Note:** The router supports only basic DDNS, and the login and password might not be secure. You can use DDNS with a VPN tunnel for a secure connection. For more information, see [Chapter 7, Access the Router's USB Drive Through the Internet](#).

---

## Set Up a New Dynamic DNS Account

➤ To set up Dynamic DNS and register for a free NETGEAR account:

1. Launch an Internet browser from a computer or wireless device that is connected to the network.
2. Type <http://www.routerlogin.net> or <http://www.routerlogin.com>.

A login screen displays.

3. Enter the router user name and password.

The user name is **admin**. The default password is **password**. The user name and password are case-sensitive.

The BASIC Home screen displays.

4. Select **ADVANCED > Advanced Settings > Dynamic DNS**.

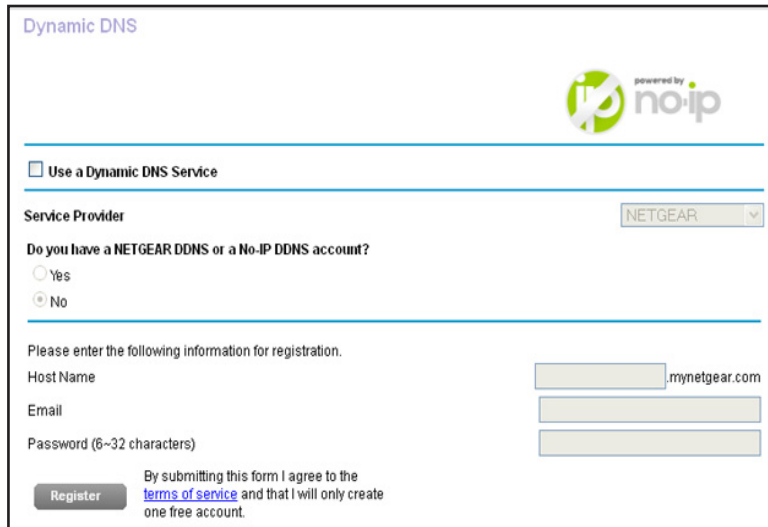

5. Select the **Use a Dynamic DNS Service** check box.
6. In the **Service Provider** list, select **NETGEAR**.
7. Select the **No** radio button.
8. In the **Host Name** field, type the name that you want to use for your URL.  
The host name is sometimes called the domain name. Your free URL includes the host name that you specify, and ends with mynetgear.com. For example, specify *MyName.mynetgear.com*.
9. In the **Email** field, type the email address for your account.
10. In the **Password (6-32 characters)** field, type the password for your account.
11. Click the **Register** button.
12. Follow the onscreen instructions to register for your NETGEAR Dynamic DNS service.

## Specify a DNS Account That You Already Use

If you already set up a Dynamic DNS account with NETGEAR no-ip, www.no-ip.com, or www.DynDNS.org, you can set up the router to use your account.

- **To set up Dynamic DNS if you already set up an account:**
  1. Launch an Internet browser from a computer or wireless device that is connected to the network.
  2. Type **http://www.routerlogin.net** or **http://www.routerlogin.com**.  
A login screen displays.
  3. Enter the router user name and password.  
The user name is **admin**. The default password is **password**. The user name and password are case-sensitive.

The BASIC Home screen displays.

4. Select **ADVANCED > Advanced Settings > Dynamic DNS.**



5. Select the **Use a Dynamic DNS Service** check box.
6. In the **Service Provider** list, select one of the following:
  - **NETGEAR**
  - **www.no-ip.com**
  - **www.DynDNS.org**
7. Select the **Yes** radio button.

The screen adjusts and displays the **Show Status**, **Cancel**, and **Apply** buttons.

8. In the **Host Name** field, type the host name (sometimes called the domain name) for your account.
9. For a www.no-ip or www.DynDNS account, in the **User Name** field, enter the user name for your account.
10. For a NETGEAR account at www.no-ip, in the **Email** field, type the email address for your account.
11. In the **Password (6-32 characters)** field, type the password for your DDNS account.
12. Click the **Apply** button.

Your changes are saved.

13. To verify that your Dynamic DNS service is enabled in the router, click the **Show Status** button.

A message displays the Dynamic DNS status.

## Change the Dynamic DNS Settings

➤ **To change your settings:**

1. Launch an Internet browser from a computer or wireless device that is connected to the network.
2. Type **http://www.routerlogin.net** or **http://www.routerlogin.com**.  
A login screen displays.
3. Enter the router user name and password.  
The user name is **admin**. The default password is **password**. The user name and password are case-sensitive.  
The BASIC Home screen displays.
4. Select **ADVANCED > Advanced Settings > Dynamic DNS**.  
The Dynamic DNS screen displays.
5. Change your DDNS account settings as necessary.
6. Click the **Apply** button.  
Your changes are saved.

## Set Up Your Personal FTP Server

➤ **To set up your personal account and use FTP:**

1. Get your free NETGEAR Dynamic DNS domain name.  
See *Your Personal FTP Server* on page 84.
2. Make sure that your Internet connection is working.  
Your router must use a direct Internet connection. It cannot connect to a different router to access the Internet.
3. Connect a USB hard disk drive to a USB port on the router.
4. Set up FTP access in the router.  
See *Set Up FTP Access Through the Internet* on page 82.
5. On a remote computer with Internet access, you can use FTP to access your router using **ftp://yourname.mynetgear.com**.



# Use the Router as a Media Server

---

# 8

The router comes set up to work as a ReadyDLNA media server. You can set up the router to play music from iTunes Server and media from TiVo.

This chapter contains the following sections:

- *Specify ReadyDLNA Media Server Settings*
- *Play Music from a USB Drive with iTunes Server*
- *Play Media from a USB Drive on TiVo*

## Specify ReadyDLNA Media Server Settings

By default, the router acts as a ReadyDLNA media server, which lets you view movies and photos on DLNA/UPnP AV-compliant media players, such as Xbox360, Playstation, and NETGEAR media players.

➤ **To specify media server settings:**

1. Launch an Internet browser from a computer or wireless device that is connected to the network.
2. Type **http://www.routerlogin.net** or **http://www.routerlogin.com**.  
A login screen displays.
3. Enter the router user name and password.  
The user name is **admin**. The default password is **password**. The user name and password are case-sensitive.  
The BASIC Home screen displays.
4. Select **ADVANCED > USB Storage > Media Server**.  
The Media Server (Settings) screen displays.
5. Specify the settings:
  - **Enable Media Server**. Select this check box to enable this device to act as a media server.
  - **Enable TiVo support**. Select this check box if you want to play ReadyNAS media on your TiVo device. See the *Play Media from a USB Drive on TiVo* on page 92.
  - **Media Server Device Name**. Specify the name of the media server.
6. Click the **Apply** button.  
Your changes are saved.

## Play Music from a USB Drive with iTunes Server

iTunes Server lets you play music with your Windows or Mac iTunes app from a USB drive that is connected to the router USB port. You can also use the Apple Remote app from an

iPhone or iPad to play music on any AirPlay devices, such as Apple TV or AirPlay-supported receivers.



Figure 11. Play music on a USB drive with iTunes

Supported music file formats are MP3, AAC, and FLAC. The maximum number of music files supported is 10,000.

➤ **To specify iTunes server settings:**

1. On your iPhone or iPad, find and connect to the WiFi network.
2. Launch the Remote app.
3. Click the **Add an iTunes Library** button.  
A passcode displays.
4. Specify the passcode in the router:
  - a. Launch an Internet browser from a computer or wireless device that is connected to the network.
  - b. Type **<http://www.routerlogin.net>** or **<http://www.routerlogin.com>**.  
A login screen displays.
  - c. Enter the router user name and password.  
The user name is **admin**. The default password is **password**. The user name and password are case-sensitive.  
The BASIC Home screen displays.

- d. Select **ADVANCED > USB Storage > Media Server**.

- e. Make sure that the **Enable iTunes Media Server (Music Only)** check box is selected.
- f. Enter the passcode.
- g. Click the **Allow Control** button.
- h. Click the **Apply** button.

Your changes are saved.

On your iPhone or iPad, the ReadySHARE music library displays in the Remote app.

You can play this music to AirPlay devices.

## Play Media from a USB Drive on TiVo

You can set up your TiVo to access media files stored on a USB device that is connected to your router. The TiVo must be on the same network as the router. This feature supports the following file formats:

- **Video.** See and play `mpeg1`, and `mpeg2` files.
- **Music.** See and play MP3 files.
- **Pictures.** View images in `.jpg` format.

### ➤ To set up the router to work with TiVo:

1. Launch an Internet browser from a computer or wireless device that is connected to the network.
2. Type <http://www.routerlogin.net> or <http://www.routerlogin.com>.

A login screen displays.

3. Enter the router user name and password.

The user name is **admin**. The default password is **password**. The user name and password are case-sensitive.

The BASIC Home screen displays.

4. Select **ADVANCED > USB Storage > Media Server**.

The Media Server Settings screen displays.

5. Make sure that the **Enable TiVo support** check box is selected.  
If you changed the setting, click the **Apply** button.  
Your settings are saved.

➤ **To play videos:**

1. On the TiVo, select **TiVo Central > My Shows**.

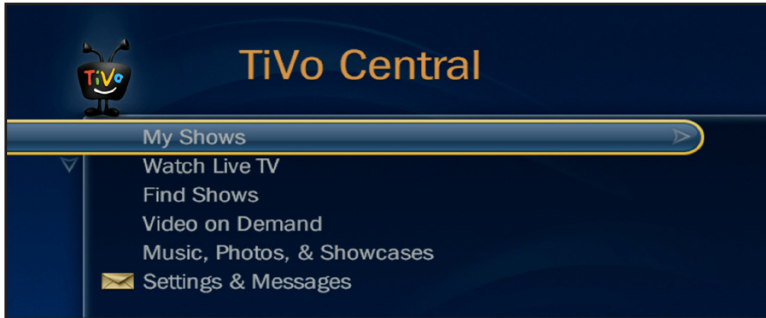

2. Go to the bottom of the list and select the R6700.



➤ **To play music or view photos:**

1. On the TiVo, select **TiVo Central > Music, Photos, & Showcases**.

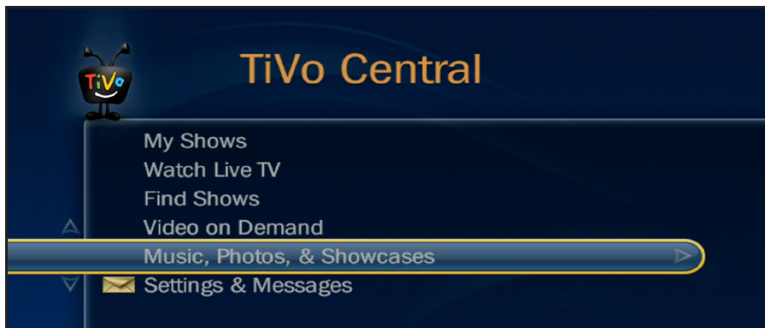

2. Select an item to play or watch.

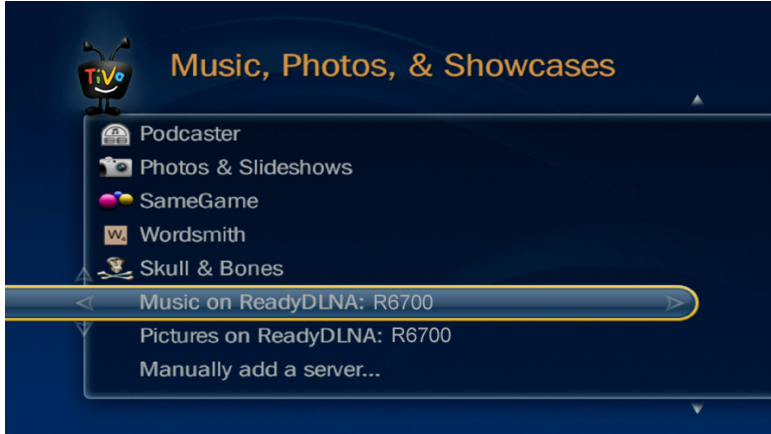

- **To copy TiVo files to a computer:**

Use the TiVo Desktop accessory, available at <https://www3.tivo.com/store/accessories-software.do>.

# 9 Share a USB Printer

---

# 9

The ReadySHARE Printer utility lets you share a USB printer that is connected to the USB port on your router. You can share this USB printer among the Windows and Mac computers on your network.

This chapter contains the following sections:

- *Install the Printer Driver and Cable the Printer*
- *Download the ReadySHARE Printer Utility*
- *Install the ReadySHARE Printer Utility*
- *Use the Shared Printer*
- *View or Change the Status of a Printer*
- *Use the Scan Feature of a Multifunction USB Printer*
- *Change NETGEAR USB Control Center Settings*

## Install the Printer Driver and Cable the Printer

Some USB printer manufacturers (for example, HP and Lexmark printers) request that you do not connect the USB cable until the installation software prompts you to do so.

➤ **To install the driver and cable the printer:**

1. On each computer on your network that shares the USB printer, install the driver software for the USB printer.

If you cannot find the printer driver, contact the printer manufacturer.

2. Use a USB printer cable to connect the USB printer to the router USB port.

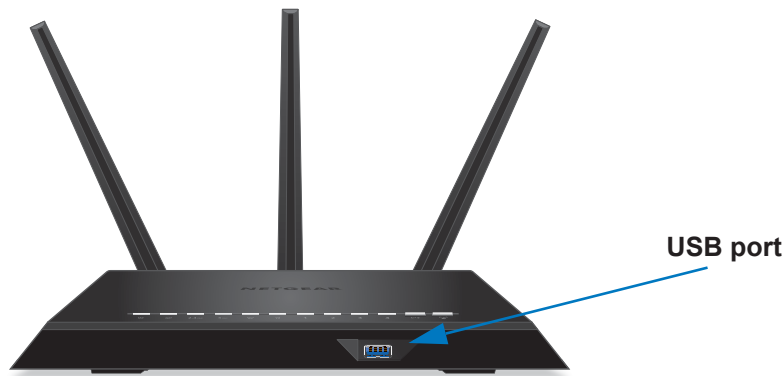

## Download the ReadySHARE Printer Utility

The utility works on Windows and Mac computers.

➤ **To download the utility:**

1. Visit [www.netgear.com/readysware](http://www.netgear.com/readysware).



**NETGEAR**  
Connect with Innovation

**ReadySHARE®**  
Easy Access and Sharing

**ReadySHARE® USB Storage Access**  
Easy shared access from any computer in your home network to an external USB hard drive connected to your router

- » Easy to Set-up: Instructions
- » PC Utility
- » How to Video

Supported Routers: AC1450, Centra WNDR4700/WNDR4720, R6300, R6250, R6200, R4500, WNDR4500, WNDR4300, WNDR3800, WNDRMAC, WNDR3700, WNDR3400, WNDR3500L, WNR2200  
Supported DSL Gateways: D6300, D6200, DGND4000, DGN33700, DGN3500, DGN2200, DGN2200v3

**ReadySHARE® Printer**  
Wirelessly print from your home network to a connected USB printer

- » Easy to Set-up: Instructions
- » PC Utility
- » MAC Utility

Supported Routers: AC1450, R6300, R6250, R6200, R4500, Centra WNDR4700/WNDR4720, WNDR4500, WNDR3800, JNR3210, WNDR4300  
Supported DSL Gateways: D6300, D6200, DGND4000, DGN33700v2



2. In the ReadySHARE Printer pane, click the **PC Utility** or **Mac Utility** link.
3. Follow the onscreen instructions to download the file.

## Install the ReadySHARE Printer Utility

You must install the ReadySHARE Printer utility on each computer that will share the printer. After you install it, the utility displays as NETGEAR USB Control Center on your computer.

➤ **To install the utility:**

1. Double-click the ReadySHARE Printer utility setup file that you downloaded.

The InstallShield wizard displays.

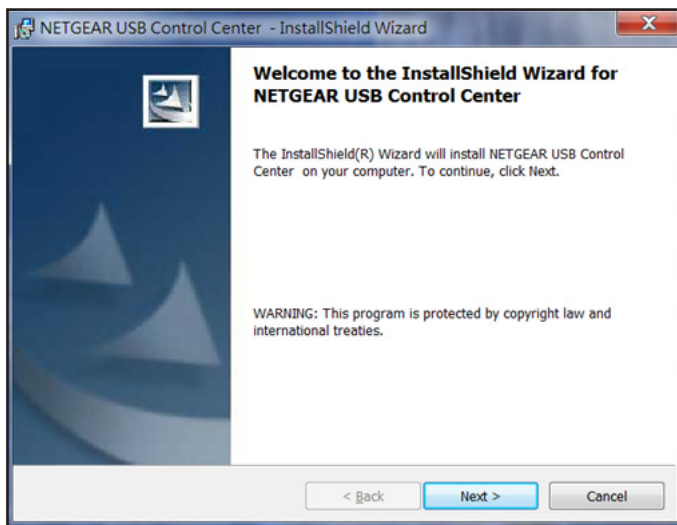

2. Follow the wizard instructions to install NETGEAR USB Control Center.

After the InstallShield Wizard completes the installation, the NETGEAR USB Control Center prompts you to select a language:



3. Select a language from the list and click the **OK** button.

The NETGEAR USB Control Center displays the main screen.

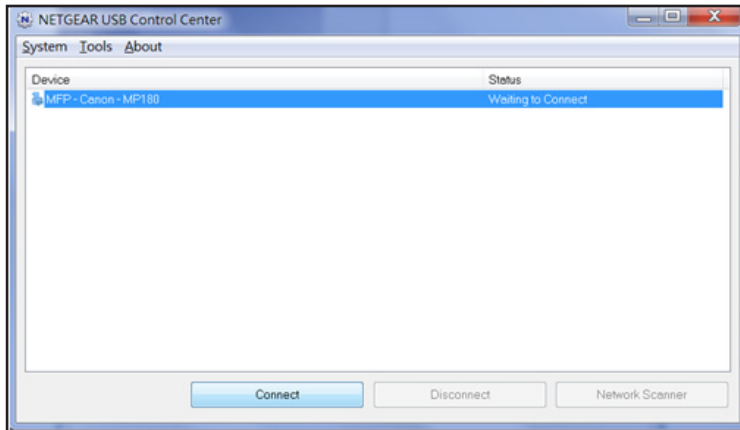

Some firewall software, such as Comodo, blocks NETGEAR USB Control Center from accessing the USB printer. If you do not see the USB printer displayed in the screen, you can disable the firewall temporarily to allow the utility to work.

4. Select the printer and click the **Connect** button.

The printer status changes to Manually connected by *Mycomputer*. Now, only your computer can use the printer.

5. Click the **Disconnect** button.

The status changes to Available. Now all computers on the network can use the printer.

6. To exit the utility, select **System > Exit**.

## Use the Shared Printer

For each computer, after you click the **Connect** and **Disconnect** buttons once, the utility automatically manages the printing queue and handling. By default, the utility starts automatically whenever you log on to Windows and runs in the background.

### ➤ To manually connect and print:

1. Click the **NETGEAR USB Control Center** icon .

The main screen displays.

2. Click the **Connect** button.

The printer status changes to Manually connected by *Mycomputer*. Now, only the computer you are using can use this printer.

3. Use the print feature in your application to print your document.
4. To release the printer so that all computers on the network can use it, click the **Disconnect** button.

➤ **To print and release the printer to any computer on the network:**

1. To print your document, use the print feature in your application.  
The NETGEAR USB Control Center automatically connects your computer to the USB printer and prints the document. If another computer is already connected to the printer, your print job goes into a queue to wait to be printed.
2. If your document does not print, use the NETGEAR USB Control Center to check the status.  
See *View or Change the Status of a Printer* on page 99.

## View or Change the Status of a Printer

➤ **To view or change the status:**

1. Click the **NETGEAR USB Control Center** icon .

The main screen displays.

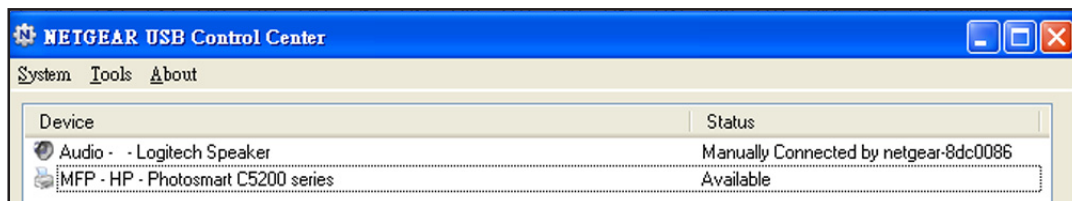

The Status column shows the status for each device:

- **Available.** No print jobs are in process. You can use the USB printer from any computer in the network.
  - **Connected.** Your computer is connected to the printer and will be released when your print job is done.
  - **Manually Connected by.** Only the connected computer can use the printer.
  - **Waiting to Connect.** Your computer is not connected to the shared printer yet.
2. To print from your computer when the status shows Manually connected by *another computer*, click the **Disconnect** button.

The printer is released from the connection and the status changes to Available.

3. To print from your computer when the status shows Waiting to Connect:
  - a. Click the **Connect** button.  
The printer status changes to Manually connected by *Mycomputer*. Now, only your computer can use the printer.
  - b. To allow the printer to be shared, click the **Disconnect** button.  
The printer is released from the connection and the status changes to Available.

## Use the Scan Feature of a Multifunction USB Printer

If your USB printer supports scanning, you can also use the USB printer for scanning. For example, the USB printer displayed in the Windows Printers and Faxes window is ready for print jobs.

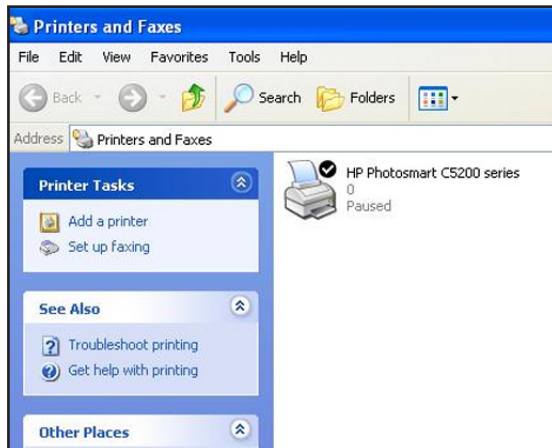

➤ **To use the scan feature of a multifunction USB printer:**

1. Launch the NETGEAR USB Control Center.
2. Make sure that the printer status shows as Available.
3. Click the **Network Scanner** button.

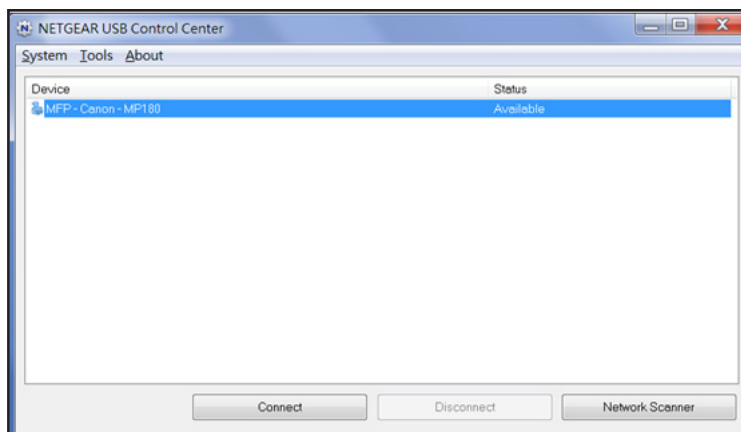

The scanner screen displays so that you can use the USB printer for scanning.

## Change NETGEAR USB Control Center Settings

You can stop the NETGEAR USB Control Center from starting automatically when you log in to Windows. You can also change the language and specify the time-out to release the printer connection.

### ➤ To turn off automatic NETGEAR USB Control Center startup:

1. Click the **NETGEAR USB Control Center** icon .

The main screen displays.

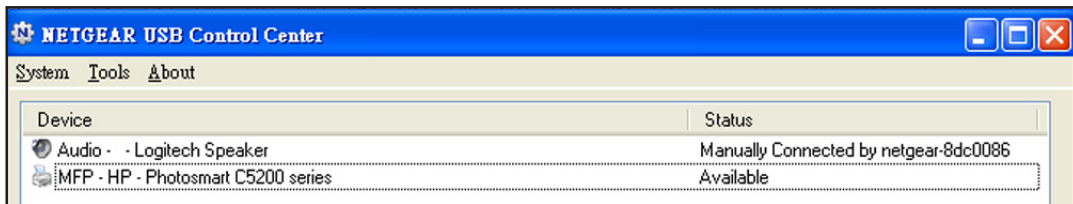

2. Select **Tools > Configuration**.

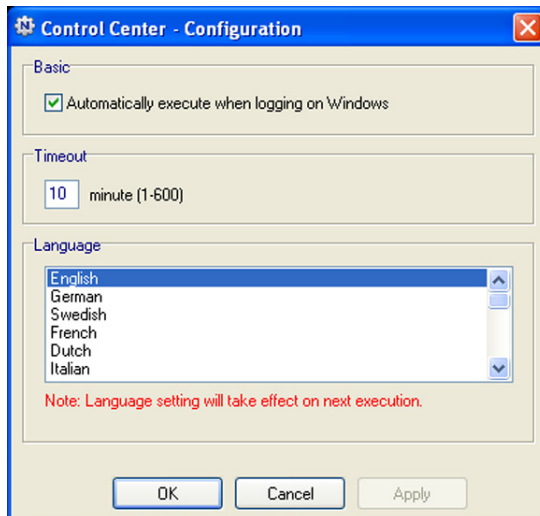

3. Clear the **Automatically execute when logging on Windows** check box.
4. Click the **OK** button.

Your change is saved.

### ➤ To change the language:

1. Select **Tools > Configuration**.
2. In the **Language** list, select a language.
3. Click the **OK** button.

The next time NETGEAR USB Control Center starts, the language changes.

➤ **To specify the time-out:**

1. Select **Tools > Configuration**.
2. In the **Timeout** field, type the number of minutes.

The time-out is the number of minutes that a computer holds its connection to the printer when the connection isn't being used.

3. Click the **OK** button.

Your change is saved.

The router comes ready for WiFi, Ethernet, and USB connections. You can customize the router's network settings. NETGEAR recommends that you install the router and connect it to the Internet before you change its network settings.

This chapter includes the following sections:

- *Disable LED Blinking or Turn Off LEDs*
- *View WAN Settings*
- *Set Up a Default DMZ Server*
- *Change the Router's Device Name*
- *Change the LAN TCP/IP Settings*
- *Specify the IP Addresses That the Router Assigns*
- *Disable the DHCP Server Feature in the Router*
- *Reserve LAN IP Addresses*
- *Use the WPS Wizard for WiFi Connections*
- *Specify Basic WiFi Settings*
- *Change the WiFi Security Option*
- *Set Up a Guest Network*
- *How the Router Manages Wireless Clients*
- *Control the Wireless Radios*
- *Set Up a Wireless Schedule*
- *Specify WPS Settings*
- *Use the Router as a Wireless Access Point*
- *Set Up the Router in Bridge Mode*
- *Set Up a Wireless Distribution System*

## Disable LED Blinking or Turn Off LEDs

The router LEDs on the top panel indicate router activities and behavior. You can disable LED blinking for network communications, or turn off all LEDs except the Power LED.

➤ **To disable LED blinking or turn off the LEDs:**

1. Launch an Internet browser from a computer or wireless device that is connected to the network.
2. Type **http://www.routerlogin.net** or **http://www.routerlogin.com**.

A login screen displays.

3. Enter the router user name and password.

The user name is **admin**. The default password is **password**. The user name and password are case-sensitive.

The BASIC Home screen displays.

4. Select **ADVANCED > Advanced Setup > LED Control Settings**.

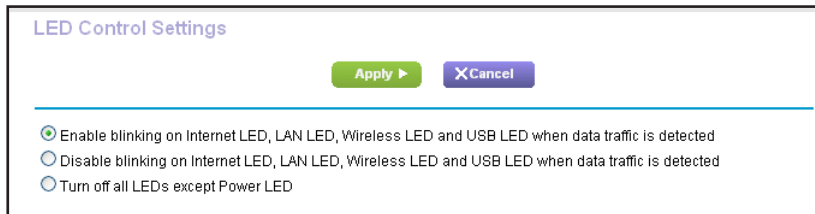

By default, the first radio button is selected, which allows standard LED behavior. For information about standard LED behavior, see [Table 1, LED and button descriptions](#) on page 10.

5. To disable blinking, select this radio button: **Disable blinking on Internet LED, LAN LED, Wireless LED, and USB LED when data traffic is detected**.
6. To turn off the LEDs, select this radio button: **Turn off all LEDs except Power LED**.
7. Click the **Apply** button.

Your change takes effect.

## View WAN Settings

You can view or configure wide area network (WAN) settings for the Internet port. You can set up a DMZ (demilitarized zone) server, change the maximum transmit unit (MTU) size, and enable the router to respond to a ping to its WAN (Internet) port.

➤ **To view the WAN settings:**

1. Launch an Internet browser from a computer or wireless device that is connected to the network.



2. Type <http://www.routerlogin.net> or <http://www.routerlogin.com>.

A login screen displays.

3. Enter the router user name and password.

The user name is **admin**. The default password is **password**. The user name and password are case-sensitive.

The BASIC Home screen displays.

4. Select **ADVANCED > Setup > WAN Setup**.

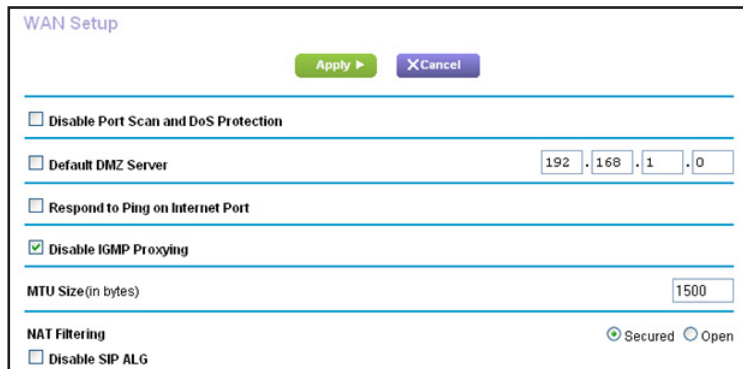

The following settings display:

- **Disable Port Scan and DoS Protection.** DoS protection protects your LAN against denial of service attacks such as Syn flood, Smurf Attack, Ping of Death, and many others. Select this check box only in special circumstances.
  - **Default DMZ Server.** This feature is sometimes helpful when you are playing online games or videoconferencing, but it makes the firewall security less effective. See [Set Up a Default DMZ Server](#) on page 106.
  - **Respond to Ping on Internet Port.** This feature allows your router to be discovered. Use this feature only as a diagnostic tool or for a specific reason.
  - **Disable IGMP Proxying.** IGMP proxying allows a computer on the local area network (LAN) to receive the multicast traffic it is interested in from the Internet. If you do not need this feature, you can select this check box to disable it.
  - **MTU Size (in bytes).** The normal MTU (maximum transmit unit) value for most Ethernet networks is 1500 bytes, or 1492 bytes for PPPoE connections. Change the MTU only if you are sure that it is necessary for your ISP connection. See [Change the MTU Size](#) on page 39.
  - **NAT Filtering.** Network Address Translation (NAT) determines how the router processes inbound traffic. Secured NAT protects computers on the LAN from attacks from the Internet, but might prevent some Internet games, point-to-point applications, or multimedia applications from working. Open NAT provides a much less secured firewall, but allows almost all Internet applications to work.
5. Click the **Apply** button.
- Your changes are saved.

## Set Up a Default DMZ Server

The default DMZ server feature is helpful when you are using some online games and videoconferencing applications that are incompatible with Network Address Translation (NAT). The router is programmed to recognize some of these applications and to work correctly with them, but other applications might not function well. In some cases, one local computer can run the application correctly if the IP address for that computer is entered as the default DMZ server.



### **WARNING:**

**DMZ servers pose a security risk. A computer designated as the default DMZ server loses much of the protection of the firewall and is exposed to exploits from the Internet. If compromised, the DMZ server computer can be used to attack other computers on your network.**

The router usually detects and discards incoming traffic from the Internet that is not a response to one of your local computers or a service that you have configured in the Port Forwarding/Port Triggering screen. Instead of discarding this traffic, you can have the router forward the traffic to one computer on your network. This computer is called the default DMZ server.

### ➤ **To set up a default DMZ server:**

1. Launch an Internet browser from a computer or wireless device that is connected to the network.
2. Type <http://www.routerlogin.net> or <http://www.routerlogin.com>.

A login screen displays.

3. Enter the router user name and password.

The user name is **admin**. The default password is **password**. The user name and password are case-sensitive.

The BASIC Home screen displays.

4. Select **ADVANCED > Setup > WAN Setup**.

The WAN Setup screen displays.

5. Select the **Default DMZ Server** check box.
6. Type the IP address.
7. Click the **Apply** button.

Your change takes effect.

## Change the Router's Device Name

The router's device name is R6700. This device name displays in a file manager when you browse your network.

➤ **To change the router's device name:**

1. Launch an Internet browser from a computer or wireless device that is connected to the network.

2. Type <http://www.routerlogin.net> or <http://www.routerlogin.com>.

A login screen displays.

3. Enter the router user name and password.

The user name is **admin**. The default password is **password**. The user name and password are case-sensitive.

The BASIC Home screen displays.

4. Select **ADVANCED > Setup > LAN Setup**.

The LAN Setup screen displays.

5. In the **Device Name** field, type a new name.

6. Click the **Apply** button.

Your change is saved.

## Change the LAN TCP/IP Settings

The router is preconfigured to use private IP addresses on the LAN side and to act as a DHCP server. The router's default LAN IP configuration is as follows:

- **LAN IP address.** 192.168.1.1
- **Subnet mask.** 255.255.255.0

These addresses are part of the designated private address range for use in private networks and are suitable for most applications. If your network requires a different IP addressing scheme, you can change these settings.

You might want to change the settings if you need a specific IP subnet that one or more devices on the network uses or if you use competing subnets with the same IP scheme.

➤ **To change the LAN TCP/IP settings:**

1. Launch an Internet browser from a computer or wireless device that is connected to the network.

2. Type <http://www.routerlogin.net> or <http://www.routerlogin.com>.

A login screen displays.

3. Enter the router user name and password.

The user name is **admin**. The default password is **password**. The user name and password are case-sensitive.

The BASIC Home screen displays.

4. Select **ADVANCED > Setup > LAN Setup**.

LAN Setup

Apply Cancel

Device Name R7000

LAN TCP/IP Setup

IP Address 192 . 168 . 1 . 1

IP Subnet Mask 255 . 255 . 255 . 0

RIP Direction Both

RIP Version Disabled

Use Router as DHCP Server

Starting IP Address 192 . 168 . 1 . 2

Ending IP Address 192 . 168 . 1 . 254

Address Reservation

#	IP Address	Device Name	MAC Address

+ Add Edit Delete

5. In the **IP Address** fields, type the IP address.

6. In the **IP Subnet Mask** fields, type the subnet mask of the router.

The IP address and subnet mask identify which addresses are local to a specific device and which must be reached through a gateway or router.

7. Change the RIP settings.

Router Information Protocol (RIP) allows a router to exchange routing information with other routers.

a. In the **RIP Direction** list, select one of the following:

- **Both**. The router broadcasts its routing table periodically and incorporates information that it receives.
- **Out Only**. The router broadcasts its routing table periodically.
- **In Only**. The router incorporates the RIP information that it receives.

b. In the **RIP Version** list, select one of the following:

- **Disabled**. This is the default setting.
- **RIP-1**. This format is universally supported. It is adequate for most networks, unless you use an unusual network setup.
- **RIP-2**. This format carries more information. Both RIP-2B and RIP-2M send the routing data in RIP-2 format. RIP-2B uses subnet broadcasting. RIP-2M uses multicasting.

8. Click the **Apply** button.

Your changes are saved.

If you changed the LAN IP address of the router, you are disconnected when this change takes effect.

- To reconnect, close your browser, relaunch it, and log in to the router.

## Specify the IP Addresses That the Router Assigns

By default, the router acts as a Dynamic Host Configuration Protocol (DHCP) server. The router assigns IP, DNS server, and default gateway addresses to all computers connected to the LAN. The assigned default gateway address is the LAN address of the router.

These addresses must be part of the same IP address subnet as the router's LAN IP address. Using the default addressing scheme, define a range between 192.168.1.2 and 192.168.1.254, although you can save part of the range for devices with fixed addresses.

### ➤ To specify the pool of IP addresses that the router assigns:

- Launch an Internet browser from a computer or wireless device that is connected to the network.
- Type <http://www.routerlogin.net> or <http://www.routerlogin.com>.

A login screen displays.

- Enter the router user name and password.

The user name is **admin**. The default password is **password**. The user name and password are case-sensitive.

The BASIC Home screen displays.

- Select **ADVANCED > Setup > LAN Setup**.

LAN Setup

Apply Cancel

Device Name R7000

LAN TCP/IP Setup

IP Address 192 . 168 . 1 . 1

IP Subnet Mask 255 . 255 . 255 . 0

RIP Direction Both

RIP Version Disabled

Use Router as DHCP Server

Starting IP Address 192 . 168 . 1 . 2

Ending IP Address 192 . 168 . 1 . 254

Address Reservation

#	IP Address	Device Name	MAC Address

+Add Edit Delete

- Make sure that the **Use Router as DHCP Server** check box is selected.
- Specify the range of IP addresses that the router assigns:
  - In the **Starting IP Address** field, type the lowest number in the range.  
This IP address must be in the same subnet as the router.

- b. In the **Ending IP Address** field, type the number at the end of the range of IP addresses.

This IP address must be in the same subnet as the router.

7. Click the **Apply** button.

Your settings are saved.

The router delivers the following parameters to any LAN device that requests DHCP:

- An IP address from the range that you define
- Subnet mask
- Gateway IP address (the router's LAN IP address)
- DNS server IP address (the router's LAN IP address)

## Disable the DHCP Server Feature in the Router

By default, the router acts as a DHCP server. The router assigns IP, DNS server, and default gateway addresses to all computers connected to the LAN. The assigned default gateway address is the LAN address of the router.

You can use another device on your network as the DHCP server, or specify the network settings of all your computers.

### ➤ To disable the DHCP server feature in the router:

1. Launch an Internet browser from a computer or wireless device that is connected to the network.
2. Type **http://www.routerlogin.net** or **http://www.routerlogin.com**.

A login screen displays.

3. Enter the router user name and password.

The user name is **admin**. The default password is **password**. The user name and password are case-sensitive.

The BASIC Home screen displays.

4. Select **ADVANCED > Setup > LAN Setup**.

LAN Setup

Apply Cancel

Device Name R7000

LAN TCP/IP Setup

IP Address 192 . 168 . 1 . 1

IP Subnet Mask 255 . 255 . 255 . 0

RIP Direction Both

RIP Version Disabled

Use Router as DHCP Server

Starting IP Address 192 . 168 . 1 . 2

Ending IP Address 192 . 168 . 1 . 254

Address Reservation

	#	IP Address	Device Name	MAC Address

+Add Edit Delete

5. Clear the **Use Router as DHCP Server** check box.
6. Click the **Apply** button.
7. (Optional) If this service is disabled and no other DHCP server is on your network, set your computer IP addresses manually so that they can access the router.

## Reserve LAN IP Addresses

When you specify a reserved IP address for a computer on the LAN, that computer always receives the same IP address each time it accesses the router's DHCP server. Assign reserved IP addresses to computers or servers that require permanent IP settings.

➤ **To reserve an IP address:**

1. Launch an Internet browser from a computer or wireless device that is connected to the network.
2. Type <http://www.routerlogin.net> or <http://www.routerlogin.com>.

A login screen displays.

3. Enter the router user name and password.

The user name is **admin**. The default password is **password**. The user name and password are case-sensitive.

The BASIC Home screen displays.

4. Select **ADVANCED > Setup > LAN Setup**.

LAN Setup

Apply Cancel

Device Name R7000

LAN TCP/IP Setup

IP Address 192 . 168 . 1 . 1

IP Subnet Mask 255 . 255 . 255 . 0

RIP Direction Both

RIP Version Disabled

Use Router as DHCP Server

Starting IP Address 192 . 168 . 1 . 2

Ending IP Address 192 . 168 . 1 . 254

Address Reservation

#	IP Address	Device Name	MAC Address

+ Add Edit Delete

- In the Address Reservation section, click the **Add** button.
- In the **IP Address** field, type the IP address to assign to the computer or server. Choose an IP address from the router's LAN subnet, such as 192.168.1.x.
- Type the MAC address of the computer or server.

**Tip:** If the computer is already on your network, you can copy its MAC address from the Attached Devices screen and paste it here.

- Click the **Apply** button.

The reserved address is entered into the table.

The reserved address is not assigned until the next time the computer contacts the router's DHCP server. Reboot the computer, or access its IP configuration and force a DHCP release and renew.

## Edit a Reserved LAN IP Address

➤ **To edit a reserved address entry:**

- Launch an Internet browser from a computer or wireless device that is connected to the network.
- Type <http://www.routerlogin.net> or <http://www.routerlogin.com>.

A login screen displays.

- Enter the router user name and password.

The user name is **admin**. The default password is **password**. The user name and password are case-sensitive.

The BASIC Home screen displays.



4. Select **ADVANCED > Setup > LAN Setup**.

The LAN Setup screen displays.

5. Select the radio button next to the reserved address.
6. Click the **Edit** button.
7. Change the settings.
8. Click the **Apply** button.

Your changes are saved.

## Delete a Reserved LAN IP Address

➤ **To delete a reserved address entry:**

1. Launch an Internet browser from a computer or wireless device that is connected to the network.
2. Type **http://www.routerlogin.net** or **http://www.routerlogin.com**.

A login screen displays.

3. Enter the router user name and password.

The user name is **admin**. The default password is **password**. The user name and password are case-sensitive.

The BASIC Home screen displays.

4. Select **ADVANCED > Setup > LAN Setup**.

The LAN Setup screen displays.

5. Select the radio button next to the reserved address.
6. Click the **Delete** button.

The address is removed.

## Use the WPS Wizard for WiFi Connections

The WPS Wizard helps you add a wireless computer or device to your WiFi network without typing the WiFi password.

➤ **To use the WPS Wizard:**

1. Launch an Internet browser from a computer or wireless device that is connected to the network.
2. Type **http://www.routerlogin.net** or **http://www.routerlogin.com**.

A login screen displays.

3. Enter the router user name and password.

The user name is **admin**. The default password is **password**. The user name and password are case-sensitive.

The BASIC Home screen displays.

4. Select **ADVANCED > WPS Wizard**.

A note explaining WPS displays.

5. Click the **Next** button.

6. Select a setup method:

- **Push button.** Click the **WPS** button on this screen.
- **PIN Number.** The screen adjusts. Enter the client security PIN, and click the **Next** button.

7. Within two minutes, go to the client device and use its WPS software to connect to the WiFi network.

The WPS process automatically sets up your wireless computer with the network password when it connects. The router WPS screen displays a confirmation message.

## Specify Basic WiFi Settings

The router comes with preset security. This means that the WiFi network name (SSID), network key (password), and security option (encryption protocol) are preset in the factory. You can find the preset SSID and password on the router label.

---

**Note:** The preset SSID and password are uniquely generated for every device to protect and maximize your wireless security.

---

*NETGEAR recommends that you do not change your preset security settings.* If you change your preset security settings, make a note of the new settings and store it in a safe place where you can easily find it.

If you use a wireless computer to change the SSID or other wireless security settings, you are disconnected when you click the **Apply** button. To avoid this problem, use a computer with a wired connection to access the router.

➤ **To specify basic wireless settings:**

1. Launch an Internet browser from a computer or wireless device that is connected to the network.
2. Type **http://www.routerlogin.net** or **http://www.routerlogin.com**.

A login screen displays.

3. Enter the router user name and password.

The user name is **admin**. The default password is **password**. The user name and password are case-sensitive.

The BASIC Home screen displays.

**4. Select Wireless.**

**5. In the Region list, select your region.**

In some locations, you cannot change this setting.

**6. To control the SSID broadcast, select or clear the Enable SSID Broadcast check box.**

When this check box is selected, the router broadcasts its network name (SSID) so that it displays when you scan for local WiFi networks on your computer or wireless device.

**7. To change the network name (SSID), type a new name in the Name (SSID) field.**

The name can be up to 32 characters long and it is case-sensitive. The default SSID is randomly generated and is on the router's label. If you change the name, make sure to write down the new name and keep it in a safe place.

**8. To change the wireless channel, select a number in the Channel list.**

In some regions, not all channels are available. Do not change the channel unless you experience interference (shown by lost connections or slow data transfers). If this happens, experiment with different channels to see which is the best.

When you use multiple access points, it is better if adjacent access points use different channels to reduce interference. The recommended channel spacing between adjacent access points is four channels (for example, use Channels 1 and 5, or 6 and 10).

**9. To change the mode, select it from the Mode list.**

At 2.4 GHz, **Up to 450 Mbps** is the default setting. The other settings are **Up to 217 Mbps** and **Up to 54 Mbps**.

At 5 GHz, **Up to 1300 Mbps** is the default setting, which allows 802.11ac and 802.11a wireless devices to join the network. The other settings are **Up to 450 Mbps** and **Up to 217 Mbps**.

**10. Click the Apply button.**

Your settings are saved.

If you connected wirelessly to the network and you changed the SSID, you are disconnected from the network.

11. Make sure that you can connect wirelessly to the network with its new settings.

If you cannot connect wirelessly, check the following:

- Is your computer or wireless device connected to another wireless network in your area? Some wireless devices automatically connect to the first open network without wireless security that they discover.
- Is your computer or wireless device trying to connect to your network with its old settings (before you changed the settings)? If it is, update the wireless network selection in your computer or wireless device to match the current settings for your network.

## Change the WiFi Security Option

Your router comes with preset WPA2 or WPA security. The password that you enter to connect to your network is unique to your router and is on the router label. NETGEAR recommends that you use the preset security, but you can change the settings. NETGEAR recommends that you do not disable security.

### ➤ To change the WPA settings:

1. Launch an Internet browser from a computer or wireless device that is connected to the network.
2. Type **http://www.routerlogin.net** or **http://www.routerlogin.com**.

A login screen displays.

3. Enter the router user name and password.

The user name is **admin**. The default password is **password**. The user name and password are case-sensitive.

The BASIC Home screen displays.

4. Select **Wireless**.
5. Under Security Options, select a WPA option.

The WPA2 options use the newest standard for the strongest security, but some older computers and wireless devices cannot use WPA2. By default, the **WPA-PSK [TKIP] + WPA2-PSK [AES]** radio button is selected so that new or old computers and wireless devices can connect to the WiFi network by using either WPA2 or WPA security.

The **Passphrase** field displays.

6. In the **Passphrase** field, enter the network key (password) that you want to use.  
It is a text string from 8 to 63 characters.

7. Write down the new password and keep it in a secure place for future reference.
8. Click the **Apply** button.

Your changes are saved.

## Set Up a Guest Network

A guest network allows visitors at your home to use the Internet without using your wireless security key. You can add a guest network to each wireless network: 2.4 GHz b/g/n and 5.0 GHz a/n.

### ➤ To set up a guest network:

1. Launch an Internet browser from a computer or wireless device that is connected to the network.
2. Type **http://www.routerlogin.net** or **http://www.routerlogin.com**.

A login screen displays.

3. Enter the router user name and password.

The user name is **admin**. The default password is **password**. The user name and password are case-sensitive.

The BASIC Home screen displays.

4. Select **Guest Network**.

5. Select any of the following wireless settings:
  - **Enable Guest Network.** When this check box is selected, the guest network is enabled, and guests can connect to your network using the SSID of this profile.

- **Enable SSID Broadcast.** If this check box is selected, the wireless access point broadcasts its name (SSID) to all wireless stations. Stations with no SSID can adopt the correct SSID for connections to this access point.
  - **Allow guests to see each other and access my local network.** If this check box is selected, anyone who connects to this SSID can access your local network, not just the Internet.
6. Give the guest network a name.
- The guest network name is case-sensitive and can be up to 32 characters. You then manually configure the wireless devices in your network to use the guest network name in addition to the main SSID.
7. Select a security option.
- The WPA2 options use the newest standard for the strongest security, but some older computers and wireless devices cannot use it. NETGEAR recommends that you select the **WPA-PSK [TKIP] + WPA2-PSK [AES]** radio button. This setting protects your WiFi network and lets computers and wireless devices connect to the WiFi network by using either WPA2 or WPA security.
8. Click the **Apply** button.
- Your settings are saved.

## How the Router Manages Wireless Clients

A wireless client is any computer or wireless device that connects to the router's WiFi network. The router uses airtime fairness and implicit beamforming to manage its wireless clients. These features are enabled by default, but you can disable them.

### Airtime Fairness

Airtime fairness ensures that all clients receive equal time on the network. Network resources are divided by time, so if five clients are connected, they each get one-fifth of the network time. The advantage of this feature is that your slowest clients don't control network responsiveness. This feature is enabled by default, but you can disable it.

#### ➤ To disable airtime fairness:

1. Launch an Internet browser from a computer or wireless device that is connected to the network.
2. Type **http://www.routerlogin.net** or **http://www.routerlogin.com**.  
A login screen displays.
3. Enter the router user name and password.  
The user name is **admin**. The default password is **password**. The user name and password are case-sensitive.

The BASIC Home screen displays.

4. Select **ADVANCED > Advanced Setup > Wireless Settings**.
5. Scroll down below the WPS Settings section of the screen and clear the **Enable AIRTIME FAIRNESS** check box.
6. Click the **Apply** button.

## Implicit Beamforming

Implicit Beamforming contrasts with explicit Beamforming, which means that your router actively tracks clients and directs power to the router antenna closest to the client. This works whether or not the client supports Beamforming. Implicit Beamforming means that the router can use information from client devices that support Beamforming to improve the WiFi signal. This feature is enabled by default, but you can disable it.

### ➤ To disable implicit Beamforming:

1. Launch an Internet browser from a computer or wireless device that is connected to the network.

2. Type **http://www.routerlogin.net** or **http://www.routerlogin.com**.

A login screen displays.

3. Enter the router user name and password.

The user name is **admin**. The default password is **password**. The user name and password are case-sensitive.

The BASIC Home screen displays.

4. Select **ADVANCED > Advanced Setup > Wireless Settings**.

The Wireless Settings screen displays.

5. Scroll down below the WPS Settings section and clear the **Enable Implicit BEAMFORMING** check box.
6. Click the **Apply** button.

## Control the Wireless Radios

The router includes internal wireless radios that broadcast signals in the 2.4 GHz and 5 GHz ranges. By default, they are on so that you can connect wirelessly to the router. When the wireless radios are off, you can still use an Ethernet cable for a LAN connection to the router.

You can turn the wireless radios on and off with the **WiFi On/Off** button on the router, or you can log in to the router and enable or disable the wireless radios. If you are close to the router, it might be easier to press its **WiFi On/Off** button. If you are away from the router or you already logged in, it might be easier to enable or disable them. You can also turn the WiFi radios off and on based on a schedule. (See *Set Up a Wireless Schedule* on page 121.)

## Use the WiFi On/Off Button

- **To turn the wireless radios off and on with the WiFi On/Off button:**

Press the **WiFi On/Off** button on the top of the router for two seconds.

If you turned off the wireless radios, the WiFi On/Off LED and the WPS LED turn off. If you turned on the wireless radios, the WiFi On/Off LED and the WPS LED light.

## Enable or Disable the Wireless Radios

If you used the **WiFi On/Off** button to turn off the wireless radios, you can't log in to the router to turn them back on. You must press the **WiFi On/Off** button again for two seconds to turn the wireless radios back on.

- **To enable or disable the wireless radios:**

1. Launch an Internet browser from a computer or wireless device that is connected to the network.
2. Type <http://www.routerlogin.net> or <http://www.routerlogin.com>.

A login screen displays.

3. Enter the router user name and password.

The user name is **admin**. The default password is **password**. The user name and password are case-sensitive.

The BASIC Home screen displays.

4. Select **ADVANCED > Advanced Setup > Wireless Settings**.

5. In the 2.4 GHz and 5 GHz sections of the screen, select or clear the **Enable Wireless Radio** check boxes.



Clearing these check boxes turns off the WiFi feature of the router.

6. Click the **Apply** button.

If you turned off both wireless radios, the WiFi On/Off LED and the WPS LED turn off. If you turned on the wireless radios, the WiFi On/Off LED and the WPS LED light.

## Set Up a Wireless Schedule

You can turn off the wireless signal from your router at times when you do not need a wireless connection. For example, you might turn it off for the weekend if you leave town.

### ➤ To set up the wireless schedule:

1. Launch an Internet browser from a computer or wireless device that is connected to the network.
2. Type <http://www.routerlogin.net> or <http://www.routerlogin.com>.

A login screen displays.

3. Enter the router user name and password.

The user name is **admin**. The default password is **password**. The user name and password are case-sensitive.

The BASIC Home screen displays.

4. Select **ADVANCED > Advanced Setup > Wireless Settings**.

The Advanced Wireless Settings screen displays.

5. Click the **Add a new period** button.

6. Use the lists, radio buttons, and check boxes to set up a period during which you want to turn off the wireless signal.
7. Click the **Apply** button.  
The Advanced Wireless Settings screen displays.
8. Select the **Turn off wireless signal by schedule** check box to activate the schedule.

9. Click the **Apply** button.  
Your settings are saved.

## Specify WPS Settings

Wi-Fi Protected Setup (WPS) lets you join the WiFi network without typing the WiFi password.

### ➤ To specify WPS Settings:

1. Launch an Internet browser from a computer or wireless device that is connected to the network.
2. Type **http://www.routerlogin.net** or **http://www.routerlogin.com**.

A login screen displays.

3. Enter the router user name and password.

The user name is **admin**. The default password is **password**. The user name and password are case-sensitive.

The BASIC Home screen displays.

4. Select **ADVANCED > Advanced Setup > Wireless Settings**.

The Router's PIN field displays the PIN that you use on a registrar (for example, from the Network Explorer on a Vista Windows computer) to configure the router's wireless settings through WPS.

5. (Optional) Select or clear the **Enable Router's PIN** check box.

The PIN function might temporarily be disabled when the router detects suspicious attempts to break into the router's wireless settings by using the router's PIN through WPS. You can manually enable the PIN function by selecting the **Enable Router's PIN** check box.

6. (Optional) Select or clear the **Keep Existing Wireless Settings** check box.

By default, the **Keep Existing Wireless Settings** check box is selected. NETGEAR recommends that you leave this check box selected.

If you clear this check box, the next time a new wireless client uses WPS to connect to the router, the router wireless settings change to an automatically generated random SSID and security key.

7. Click the **Apply** button.  
Your changes are saved.

## Use the Router as a Wireless Access Point

You can set up the router to run as an access point (AP) on the same local network as another router.

➤ **To set up the router as an AP:**

1. Use an Ethernet cable to connect the Internet port of this router to an Ethernet port in the other router.



2. Launch an Internet browser from a computer or wireless device that is connected to the network.
3. Type **http://www.routerlogin.net** or **http://www.routerlogin.com**.  
A login screen displays.

4. Enter the router user name and password.

The user name is **admin**. The default password is **password**. The user name and password are case-sensitive.

The BASIC Home screen displays.

5. Select **ADVANCED > Advanced Setup > Wireless AP**.

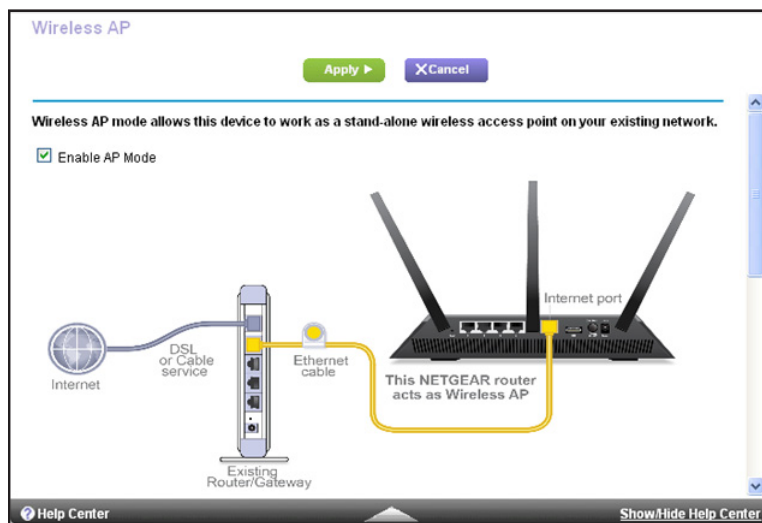

6. Select the **Enable AP Mode** check box.

7. Scroll down and select an IP address setting radio button:
  - **Get dynamically from existing router.** The other router on the network assigns an IP address to this router while this router is in AP mode.
  - **Enable fixed IP settings on this device (not recommended).** Use this setting if you want to manually assign a specific IP address to this router while it is in AP mode. Using this option effectively requires advanced network experience.

**Note:** To avoid interference with other routers or gateways in your network, NETGEAR recommends that you use different wireless settings on each router. You can also turn off the wireless radio on the other router or gateway and use the R6700 router only for wireless client access.

8. Click the **Apply** button.

The IP address of the router changes, and you are disconnected.
9. To reconnect, close and restart your browser and type **http://www.routerlogin.net**.

## Set Up the Router in Bridge Mode

You can use your router in bridge mode to connect multiple devices wirelessly at the faster 802.11ac speed. You need two routers: one set up as a router and the other set up as a bridge.

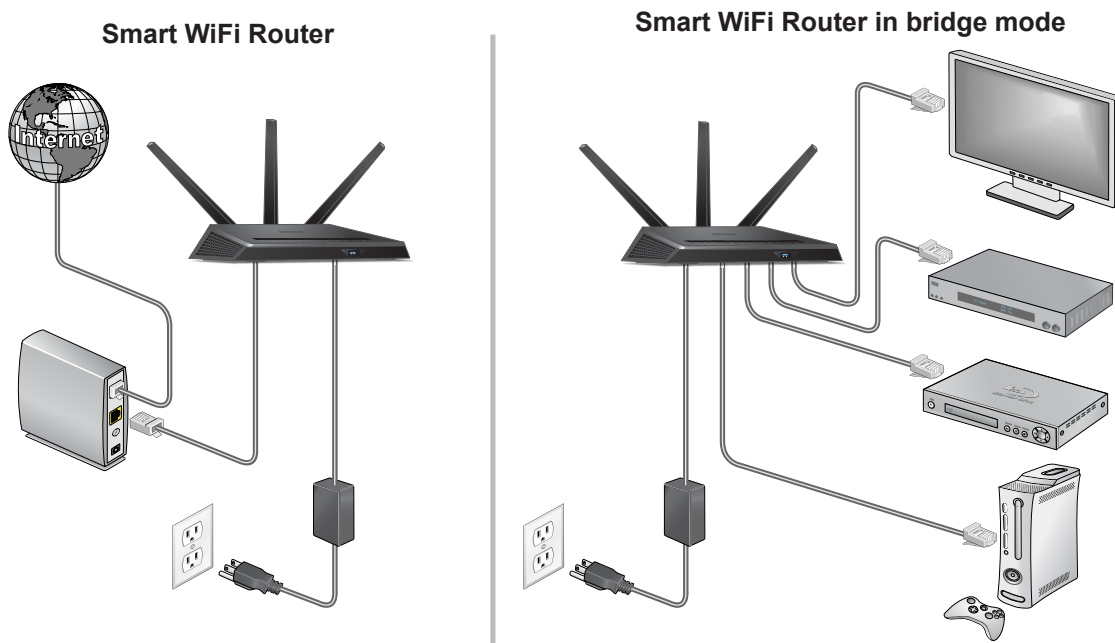

**Figure 12. Router in bridge mode with an 802.11ac WiFi connection**

Installing your R6700 router as a bridge offers the following benefits:

- Take advantage of gigabit WiFi speeds on current devices.

- Use Gigabit WiFi for applications like video and gaming.
- Connect multiple devices like NAS, Smart TV, NeoTV, Blu-ray player, and game consoles at gigabit WiFi speeds using a WiFi link.
- Avoid the need for separate WiFi adapters for each device.

For example, you can install the first router in a room like a home office where you connect to the Internet, then set up the second router in bridge mode. Place the router in bridge mode in a different room with your home entertainment center. Cable the router in bridge mode to your Smart TV, DVR, game console or Blu-ray player, and use its 802.11ac WiFi connection to the first router.

➤ **To set up bridge mode:**

1. Make a note of the WiFi settings of the other router to which this router will connect.

You need to know the SSID, WiFi security mode, wireless password, and operating frequency (either 2.4 GHz or 5 GHz).

2. Launch an Internet browser from a computer or wireless device that is connected to the network.
3. Type **http://www.routerlogin.net** or **http://www.routerlogin.com**.

A login screen displays.

4. Enter the router user name and password.

The user name is **admin**. The default password is **password**. The user name and password are case-sensitive.

The BASIC Home screen displays.

5. Select **ADVANCED > Advanced Setup > Wireless Settings**.

The Wireless Settings screen displays.

6. Scroll down and select the **Use other operation mode** check box.
7. Select the **Enable Bridge mode** radio button.

The screen adjusts.

The screenshot shows the 'Wireless Settings' page with the following configuration:

- use other operation mode
- Enable Bridge mode
- ▶ setup bridge mode wireless settings**
- Device Name: R6700
- Get IP Address Dynamically
  - IP Address: 0 . 0 . 0 . 0
  - IP Subnet Mask: 0 . 0 . 0 . 0
  - Gateway IP Address: 0 . 0 . 0 . 0
- Get DNS Server Address Dynamically
  - Primary DNS: . . . .
  - Secondary DNS: . . . .

8. Click the **setup bridge mode wireless settings** button.

Wireless Settings

Apply Cancel

Choose a Wireless Networks: Wireless Networks (2.4Ghz b/g/n)

Name (SSID): NETGEAR96

**Security Options**

None

WEP

WPA-PSK [TKIP]

WPA2-PSK [AES]

WPA-PSK [TKIP] + WPA2-PSK [AES]

Passphrase: huskyocean593 (8-63 characters or 64 hex digits)

9. Specify the settings of the other router to which this router will connect.
- Select the wireless network frequency (**2.4 GHz** or **5 GHz**).  
For 802.11ac mode, select **5 GHz**.
  - In the **Name (SSID)** field, enter the wireless network name (SSID).
  - In the Security Option section, select a radio button.
  - If prompted, type the passphrase (the WiFi password that you use to connect wirelessly to the other router).
10. Click the **Apply** button.

The settings for the other router are saved and the Advanced Wireless Settings screen displays.

11. Click the **Apply** button.

Your changes take effect.

## Set Up a Wireless Distribution System

The router can act as a wireless base station or a wireless repeater in a wireless distribution system (WDS). A WDS expands a wireless network through multiple access points. A wireless base station connects to the Internet, can be connected to wired and wireless clients, and sends its wireless signal to an access point that functions as a wireless repeater. A wireless repeater can also be connected to wired and wireless clients, but connects to the

Internet through the wireless base station. The following figure shows a wireless repeating scenario.

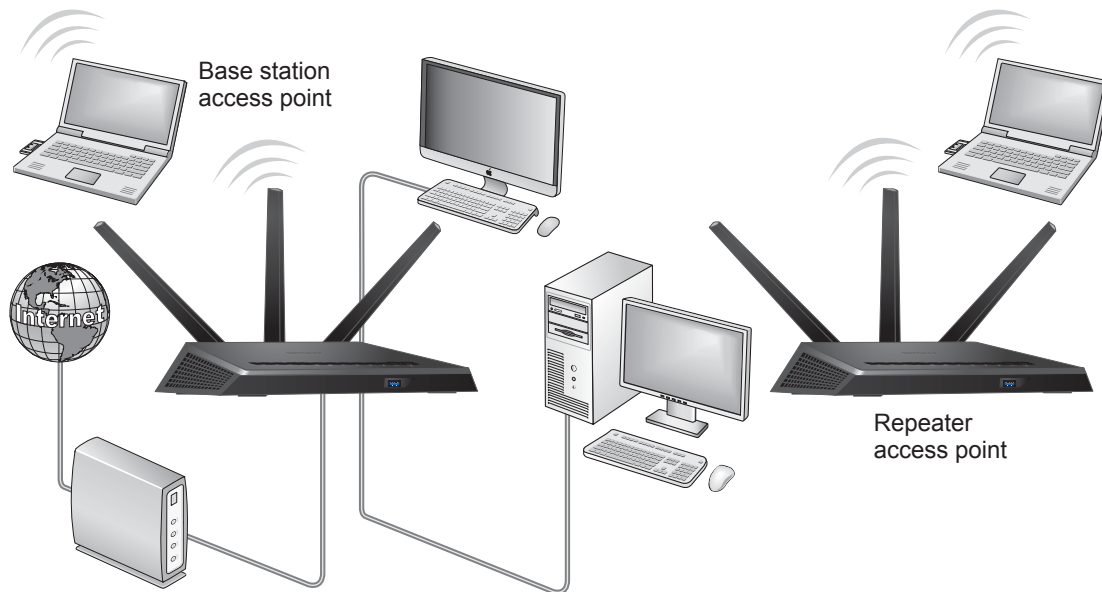

**Figure 13. Wireless repeating scenario**

**Note:** For you to use the wireless repeating function, security for your router cannot be enabled and the router cannot use the auto channel feature.

You must set up a wireless base station and a wireless repeater:

- **Wireless base station.** The router acts as the parent access point that bridges traffic to and from the child repeater access point. The base station also handles wireless and wired local computers. To configure this mode, you must know the MAC addresses of the child repeater access point. Often, the MAC address is on the product label.
- **Wireless repeater.** The router sends all traffic from its local wireless or wired computers to a remote access point. To configure this mode, you must know the MAC address of the remote parent access point.

The router is always in dual-band concurrent mode, unless you turn off one radio. If you enable the wireless repeater in either radio band, the wireless base station or wireless repeater cannot be enabled in the other radio band. However, if you enable the wireless base station in either radio band and use the other radio band as a wireless router or wireless base station, dual-band concurrent mode is not affected.

Before you can set up a wireless network with WDS, both access points must meet the following conditions:

- Use the same SSID, wireless channel, and encryption mode.
- Be on the same LAN IP subnet. That is, all of the access point LAN IP addresses are in the same network.
- All LAN devices (wired and wireless computers) are configured to operate in the same LAN network address range as the access points.

## Set Up the Base Station

The wireless repeating function works only in hub and spoke mode. The units cannot be daisy-chained. You must know the wireless settings for both units. You must know the MAC address of the remote unit. First, set up the base station, then set up the repeater.

➤ **To set up the base station:**

1. Set up both units with the same wireless settings.

The SSID and mode must be the same and the wireless security option must be set to **None**.

2. Launch an Internet browser from a computer or wireless device that is connected to the network.
3. Type <http://www.routerlogin.net> or <http://www.routerlogin.com>.

A login screen displays.

4. Enter the router user name and password.

The user name is **admin**. The default password is **password**. The user name and password are case-sensitive.

The BASIC Home screen displays.

5. Select **ADVANCED > Advanced Setup > Wireless Repeating Function**.

6. Select the **Enable Wireless Repeating Function** check box.
7. Select the **Wireless Base Station** radio button.
8. To prevent wireless clients from associating with the base station and allow LAN client associations only, select the **Disable Wireless Client Association** check box.



You can leave the check box cleared if you prefer wireless clients to be able to associate with the base stations.

9. In the **Repeater MAC Address 1** through **4** fields, enter the MAC addresses for the access points that should function as repeaters.

If your router is the base station, it can function as the “parent” for up to four other access points.

10. Click the **Apply** button.

Your changes are saved.

## Set Up a Repeater

Use a wired Ethernet connection to set up the repeater unit to avoid conflicts with the wireless connection to the base station.

If you are using the router as the base station with a non-NETGEAR router as the repeater, you might need to change more configuration settings. In particular, disable the DHCP server function on the access point that is the repeater.

### ➤ To configure a NETGEAR router as a repeater:

1. Launch an Internet browser from a computer or wireless device that is connected to the network of the router to be the repeater.

2. Type **http://www.routerlogin.net** or **http://www.routerlogin.com**.

A login screen displays.

3. Enter the router user name and password.

The user name is **admin**. The default password is **password**. The user name and password are case-sensitive.

The BASIC Home screen displays.

4. Select **Wireless**.

The Wireless screen displays.

5. Verify that the wireless settings match the base unit exactly.

The wireless security option must be set to **None**.

6. Select **ADVANCED > Wireless Repeating Function**.

The Wireless Repeating Function screen displays.

7. Select the **Enable Wireless Repeating Function** check box.

8. Select the **Wireless Repeater** radio button.

9. In the **Repeater IP Address** fields, type the IP address of the repeater router.  
This IP address must be in the same subnet as the base station, but different from the LAN IP address of the base station.
10. To prevent wireless clients from associating with the repeater and allowing LAN client associations only, select the **Disable Wireless Client Association** check box.  
You can leave the check box cleared if you prefer wireless clients to be able to associate with the repeater.
11. In the **Base Station MAC Address** fields, enter the MAC addresses for the access point that will be the base station.
12. Click the **Apply** button.  
Your changes are saved.
13. Verify connectivity across the LANs.  
A computer on any wireless or wired LAN segment of the router can connect to the Internet or share files and printers with any other computer or server connected to the other access point.

# Manage Your Network

---

# 11

This chapter describes the router settings for administering and maintaining your router and home network.

This chapter includes the following sections:

- *Update the Router Firmware*
- *Change the admin Password*
- *Set Up Password Recovery*
- *Recover the admin Password*
- *View Router Status*
- *View Logs of Router Activity*
- *Monitor Internet Traffic*
- *Create Custom Static Routes*
- *View Devices Currently on the Network*
- *Manage the Router Configuration File*
- *Remote Management*

## Update the Router Firmware

The router firmware (routing software) is stored in flash memory. You might see a message at the top of the genie screens when new firmware is available. You can respond to that message to update the firmware, or you can check to see if new firmware is available, and to update your product.

### ➤ To check for new firmware and update your router:

1. Launch an Internet browser from a computer or wireless device that is connected to the network.

2. Type **http://www.routerlogin.net** or **http://www.routerlogin.com**.

A login screen displays.

3. Enter the router user name and password.

The user name is **admin**. The default password is **password**. The user name and password are case-sensitive.

The BASIC Home screen displays.

4. Select **ADVANCED > Administration > Router Update**.

The Router Update screen displays.

5. Click the **Check** button.

The router finds new firmware information if any is available and displays a message asking if you want to download and install it.

6. Click the **Yes** button.

The router locates and downloads the firmware and begins the update.



### **WARNING:**

**To avoid the risk of corrupting the firmware, do not interrupt the update. For example, do not close the browser, click a link, or load a new page. Do not turn off the router.**

When the update is complete, your router restarts. The update process typically takes about one minute. Read the new firmware release notes to find out if you need to reconfigure the router after updating.

## Change the admin Password

This feature let you change the default password that is used to log in to the router with the user name admin. This password is not the one that you use for WiFi access.

---

**Note:** Be sure to change the password for the user name admin to a secure password. The ideal password contains no dictionary words from any language and contains uppercase and lowercase letters, numbers, and symbols. It can be up to 30 characters.

---

➤ **To set the password for the user name admin:**

1. Launch an Internet browser from a computer or wireless device that is connected to the network.
2. Type <http://www.routerlogin.net> or <http://www.routerlogin.com>.

A login screen displays.

3. Enter the router user name and password.

The user name is **admin**. The default password is **password**. The user name and password are case-sensitive.

The BASIC Home screen displays.

4. Select **ADVANCED > Administration > Set Password**.

5. Type the old password, and type the new password twice.
6. To be able to recover the password, select the **Enable Password Recovery** check box. NETGEAR recommends that you enable password recovery.
7. Click the **Apply** button.  
Your changes take effect.

## Set Up Password Recovery

NETGEAR recommends that you enable password recovery if you change the password for the router user name admin. Then you can recover the password if it is forgotten. This recovery process is supported in Internet Explorer, Firefox, and Chrome browsers, but not in the Safari browser.

➤ **To set up password recovery:**

1. Launch an Internet browser from a computer or wireless device that is connected to the network.
2. Type **http://www.routerlogin.net** or **http://www.routerlogin.com**.  
A login screen displays.
3. Enter the router user name and password.  
The user name is **admin**. The default password is **password**. The user name and password are case-sensitive.  
The BASIC Home screen displays.
4. Select **ADVANCED > Administration > Set Password**.  
The Set Password screen displays.
5. Select the **Enable Password Recovery** check box.
6. Select two security questions and provide answers to them.
7. Click the **Apply** button.  
Your changes are saved.

## Recover the admin Password

➤ **To recover your password:**

1. In the address field of your browser, type **www.routerlogin.net**.  
A login screen displays.
2. Click the **Cancel** button.  
If password recovery is enabled, are prompted to enter the serial number of the router.  
The serial number is on the product label.
3. Enter the serial number of the router.
4. Click the **Continue** button.  
A screen displays requesting the answers to your security questions.
5. Enter the saved answers to your security questions.
6. Click the **Continue** button.  
A screen displays your recovered password.
7. Click the **Login again** button.  
A login screen displays.
8. With your recovered password, log in to the router.

## View Router Status

### ➤ To view router status and usage information:

1. Launch an Internet browser from a computer or wireless device that is connected to the network.
2. Type <http://www.routerlogin.net> or <http://www.routerlogin.com>.

A login screen displays.

3. Enter the router user name and password.

The user name is **admin**. The default password is **password**. The user name and password are case-sensitive.

The BASIC Home screen displays.

4. Click the **ADVANCED** tab.

✓ Router Information		✓ Internet Port	
Hardware Version	R6700	MAC Address	E4:F4:C6:05:49:17
Firmware Version	V1.0.0.2_1.0.1	IP Address	172.24.1.108
GUI Language Version	V1.0.0.2_1.38.1	Connection	DHCP
<a href="#">LAN Port</a>		IP Subnet Mask	255.255.240.0
MAC Address	E4:F4:C6:05:49:16		172.24.0.7
IP Address	192.168.1.1	Domain Name Server	172.24.0.6
DHCP	On		10.1.1.6
<a href="#">Reboot</a>		<a href="#">Show Statistics</a> <a href="#">Connection Status</a>	

✓ Wireless Settings (2.4GHz)		✓ Wireless Settings (5GHz)	
Name (SSID)	NETGEAR92	Name (SSID)	NETGEAR92-5G
Region	North America	Region	North America
Channel	Auto (6)	Channel	149 + 153(P) + 157 + 161
Mode	Up to 450 Mbps	Mode	Up to 1300 Mbps
Wireless AP	On	Wireless AP	On
Broadcast Name	On	Broadcast Name	On
Wi-Fi Protected Setup	Configured	Wi-Fi Protected Setup	Configured

✗ Guest Network (2.4 GHz)		✗ Guest Network (5 GHz)	
Name (SSID)	NETGEAR-Guest	Name (SSID)	NETGEAR-5G-Guest
Wireless AP	Off	Wireless AP	Off
Broadcast Name	On	Broadcast Name	On

5. For information about the displayed settings, click the **Show/Hide Help Center** link at the bottom of the screen.

## Display Internet Port Statistics

### ➤ To display Internet port statistics:

1. Launch an Internet browser from a computer or wireless device that is connected to the network.
2. Type <http://www.routerlogin.net> or <http://www.routerlogin.com>.

A login screen displays.

3. Enter the router user name and password.

The user name is **admin**. The default password is **password**. The user name and password are case-sensitive.

4. The BASIC Home screen displays
5. Click the **ADVANCED** tab.

The ADVANCED Home screen displays.

6. In the Internet Port pane, click the **Show Statistics** button.

Show Statistics							
System Up Time 00:09:15							
Port	Status	TxPkts	RxPkts	Collisions	Tx B/s	Rx B/s	Up Time
WAN	1000MFull	887	7078	0	308	3584	00:06:57
LAN1	Link Down	1872	1600	0	3474	432	--
LAN2	Link Down						--
LAN3	1000MFull						00:09:15
LAN4	Link Down						--
2.4G WLAN b/g/n	217M	0	0	0	0	0	00:08:57
5G WLAN a/n/ac	1300M	0	0	0	0	0	00:08:57

Poll Interval:  (5~86400 Seconds) Set Interval Stop

The following information displays:

- **System Up Time.** The time elapsed since the router was last restarted.
  - **Port.** The statistics for the WAN (Internet) and LAN (Ethernet) ports. For each port, the screen displays the following information:
    - **Status.** The link status of the port.
    - **TxPkts.** The number of packets transmitted on this port since reset or manual clear.
    - **RxPkts.** The number of packets received on this port since reset or manual clear.
    - **Collisions.** The number of collisions on this port since reset or manual clear.
    - **Tx B/s.** The current transmission (outbound) bandwidth used on the WAN and LAN ports.
    - **Rx B/s.** The current reception (inbound) bandwidth used on the WAN and LAN ports.
    - **Up Time.** The time elapsed since this port acquired the link.
    - **Poll Interval.** The interval at which the statistics are updated in this screen.
7. To change the polling frequency, enter a time in seconds in the **Poll Interval** field and click the **Set Interval** button.

To stop the polling entirely, click the **Stop** button.



## Check the Internet Connection Status

➤ **To check the Internet connection status:**

1. Launch an Internet browser from a computer or wireless device that is connected to the network.
2. Type **http://www.routerlogin.net** or **http://www.routerlogin.com**.

A login screen displays.

3. Enter the router user name and password.

The user name is **admin**. The default password is **password**. The user name and password are case-sensitive.

The BASIC Home screen displays.

4. Click the **ADVANCED** tab.

The ADVANCED Home screen displays.

5. In the Internet Port pane, click the **Connection Status** button.

Connection Status	
IP Address	10.1.10.16
Subnet Mask	255.255.255.0
Default Gateway	10.1.10.1
DHCP Server	10.1.10.1
DNS Server	75.75.75.75 75.75.76.76
Lease Obtained	7 days,0 Hours,0 minutes
Lease Expires	6 days,23 Hours,52 minutes
<input type="button" value="Release"/> <input type="button" value="Renew"/>	
<input type="button" value="Close Window"/>	

The following information displays:

- **IP Address.** The IP address that is assigned to the router.
  - **Subnet Mask.** The subnet mask that is assigned to the router.
  - **Default Gateway.** The IP address for the default gateway that the router communicates with.
  - **DHCP Server.** The IP address for the Dynamic Host Configuration Protocol server that provides the TCP/IP configuration for all the computers that are connected to the router.
  - **DNS Server.** The IP address of the Domain Name Service server that provides translation of network names to IP addresses.
  - **Lease Obtained.** The date and time when the lease was obtained.
  - **Lease Expires.** The date and time that the lease expires.
6. To return the status of all items to 0, click the **Release** button.
  7. To refresh the screen, click the **Renew** button.

- To exit the screen, click the **Close Window** button.

## View Logs of Router Activity

The log is a detailed record of the websites you have accessed or attempted to access and other router actions. Up to 256 entries are stored in the log. Log entries display only when keyword blocking is enabled and no log entries are made for the trusted user.

### ➤ To view logs:

- Launch an Internet browser from a computer or wireless device that is connected to the network.
- Type <http://www.routerlogin.net> or <http://www.routerlogin.com>.

A login screen displays.

- Enter the router user name and password.

The user name is **admin**. The default password is **password**. The user name and password are case-sensitive.

The BASIC Home screen displays.

- Select **ADVANCED > Administration > Logs**.

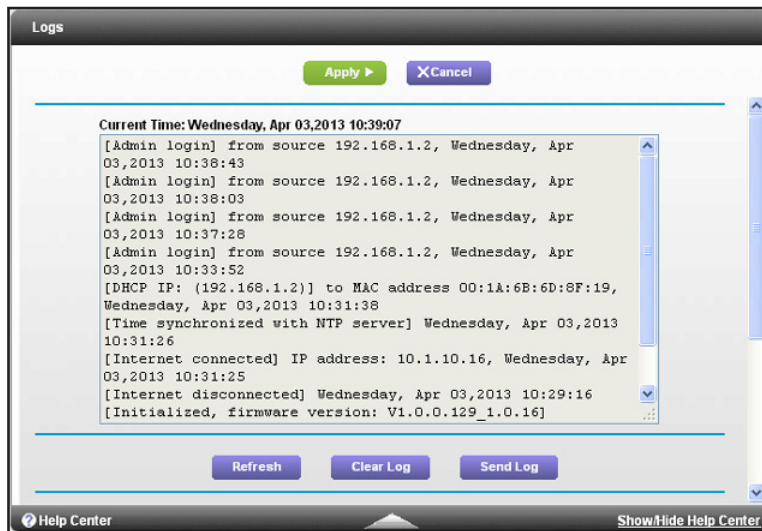

The Logs screen shows the following information:

- Action.** The action that occurred, such as whether Internet access was blocked or allowed.
- Date and time.** The date and time the log entry was recorded.
- Source IP.** The IP address of the initiating device for this log entry.
- Target address.** The name or IP address of the website or news group visited or to which access was attempted.

- To customize the logs, scroll down and clear or select the check boxes.

To refresh the log screen, click the **Refresh** button.

To clear the log entries, click the **Clear Log** button.

To email the log immediately, click the **Send Log** button.

## Monitor Internet Traffic

Traffic metering allows you to monitor the volume of Internet traffic that passes through the router Internet port. You can set limits for traffic volume.

### ➤ To monitor Internet traffic:

- Launch an Internet browser from a computer or wireless device that is connected to the network.
- Type <http://www.routerlogin.net> or <http://www.routerlogin.com>.

A login screen displays.

- Enter the router user name and password.

The user name is **admin**. The default password is **password**. The user name and password are case-sensitive.

The BASIC Home screen displays.

- Select **ADVANCED > Advanced Setup > Traffic Meter**.

Scroll to view more settings

- Select the **Enable Traffic Meter** check box.
- (Optional) Control the volume of Internet traffic.

You can use either the traffic volume control feature or the connection time control feature:

- Select the **Traffic volume control by** radio button and then select one of the following options:
    - **No Limit.** No restriction is applied when the traffic limit is reached.
    - **Download only.** The restriction is applied to incoming traffic only.
    - **Both Directions.** The restriction is applied to both incoming and outgoing traffic.
  - Select the **Connection time control** radio button and enter the allowed hours in the **Monthly limit** field.
7. (Optional) If your ISP charges for extra data volume when you make a new connection, enter the extra data volume in MB in the **Round up data volume for each connection by** field.
  8. In the Traffic Counter section, set the traffic counter to begin at a specific time and date. If you want the traffic counter to start immediately, click the **Restart Counter Now** button.
  9. In the Traffic Control section, specify whether the router will issue a warning message before the monthly limit of Mbytes or hours is reached.
 

By default, the value is 0 and no warning message is issued. You can select one of the following to occur when the limit is attained:

    - The Internet LED blinks green or amber.
    - The Internet connection is disconnected and disabled.
  10. Click the **Apply** button.
 

The Internet Traffic Statistics section helps you to monitor the data traffic.
  11. To update the Traffic Statistics section, click the **Refresh** button.
  12. To display more information about the data traffic on your router and to change the poll interval, click the **Traffic Status** button.

## Create Custom Static Routes

Typically, you do not need to add static routes unless you use multiple routers or multiple IP subnets on your network.

As an example of when a static route is needed, consider the following case:

- Your main Internet access is through a cable modem to an ISP.
- You use an ISDN router on your home network for connecting to the company where you are employed. This router's address on your LAN is 192.168.1.100.
- Your company's network address is 134.177.0.0.

When you set up your router, two implicit static routes were created. A default route was created with your ISP as the gateway, and a second static route was created to your local network for all 192.168.1.x addresses. With this configuration, if you try to access a device on

the 134.177.0.0 network, your router forwards your request to the ISP. The ISP forwards your request to the company where you are employed and the company firewall is likely to deny the request.

In this case you must define a static route, telling your router to access 134.177.0.0 through the ISDN router at 192.168.1.100. Here is an example:

- The **Destination IP Address** and **IP Subnet Mask** fields specify that this static route applies to all 134.177.x.x addresses.
- The **Gateway IP Address** field specifies that all traffic for these addresses will be forwarded to the ISDN router at 192.168.1.100.
- A metric value of 1 works because the ISDN router is on the LAN.
- The **Private** check box is selected only as a precautionary security measure in case RIP is activated.

➤ **To set up a static route:**

1. Launch an Internet browser from a computer or wireless device that is connected to the network.
2. Type <http://www.routerlogin.net> or <http://www.routerlogin.com>.

A login screen displays.

3. Enter the router user name and password.

The user name is **admin**. The default password is **password**. The user name and password are case-sensitive.

The BASIC Home screen displays.

4. Select **ADVANCED > Advanced Setup > Static Routes**.

The Static Routes screen displays.

5. Click the **Add** button.

6. In the **Route Name** field, type a name for this static route (for identification purposes only.)
7. To limit access to the LAN only, select the **Private** check box.  
If the **Private** checkbox is selected, the static route is not reported in RIP.
8. To make this route effective, select the **Active** check box.
9. Type the IP address of the final destination.

10. Type the IP subnet mask for this destination.

If the destination is a single host, type **255.255.255.255**.

11. Type the gateway IP address, which must be on the same LAN segment as the router.

12. Type a number from 1 through 15 as the metric value.

This value represents the number of routers between your network and the destination. Usually, a setting of 2 or 3 works, but if this is a direct connection, set it to **1**.

13. Click the **Apply** button.

The static route is added.

## Edit a Static Router

### ➤ To edit a static route:

1. Launch an Internet browser from a computer or wireless device that is connected to the network.

2. Type **http://www.routerlogin.net** or **http://www.routerlogin.com**.

A login screen displays.

3. Enter the router user name and password.

The user name is **admin**. The default password is **password**. The user name and password are case-sensitive.

The BASIC Home screen displays.

4. Select **ADVANCED > Advanced Setup > Static Routes**.

The Static Routes screen displays.

5. In the table, select the radio button for the route.

6. Click the **Edit** button.

The Static Routes screen adjusts.

7. Edit the route information.

8. Click the **Apply** button.

Your changes are saved.

## Delete a Static Router

### ➤ To delete a static route:

1. Launch an Internet browser from a computer or wireless device that is connected to the network.

2. Type **http://www.routerlogin.net** or **http://www.routerlogin.com**.

A login screen displays.

3. Enter the router user name and password.

The user name is **admin**. The default password is **password**. The user name and password are case-sensitive.

The BASIC Home screen displays.

4. Select **ADVANCED > Advanced Setup > Static Routes**.

The Static Routes screen displays.

5. In the table, select the radio button for the route.

6. Click the **Delete** button.

The route is removed from the table.

## View Devices Currently on the Network

You can view all computers or devices that are currently connected to your network.

### ➤ To view devices on the network:

1. Launch an Internet browser from a computer or wireless device that is connected to the network.
2. Type **http://www.routerlogin.net** or **http://www.routerlogin.com**.

A login screen displays.

3. Enter the router user name and password.

The user name is **admin**. The default password is **password**. The user name and password are case-sensitive.

The BASIC Home screen displays.

4. Select **Attached Devices**.

Attached Devices			
Go to <a href="#">Access Control</a> to allow or block devices.			
Access Control: Turned Off <span style="float: right;">C Refresh</span>			
Wired Devices			
#	IP Address	MAC Address	Device Name
1	192.168.1.2	8C:AE:4C:FE:B8:E9	TVs-MacBook-Air
2.4G Wireless Devices (Wireless intruders also show up here)			
SSID	IP Address	MAC Address	Device Name
5G Wireless Devices (Wireless intruders also show up here)			
SSID	IP Address	MAC Address	Device Name

The Wired Devices section lists devices that are connected to the router with Ethernet cables. The Wireless Devices section lists devices that are connected to the wireless network. The following information is displayed

- **#** (number). The order in which the device joined the network.
- **IP Address**. The IP address that the router assigned to this device when it joined the network. This number can change if a device is disconnected and rejoins the network.

- **MAC Address.** The unique MAC address for each device does not change. The MAC address is typically shown on the product label.
  - **Device Name.** If the device name is known, it is shown here.
5. To update this screen, click the **Refresh** button.

## Manage the Router Configuration File

The configuration settings of the router are stored within the router in a configuration file. You can back up (save) this file to your computer, restore the settings, or reset the router to the factory default settings.

### Back Up Settings

➤ **To back up the router's configuration settings:**

1. Launch an Internet browser from a computer or wireless device that is connected to the network.
2. Type <http://www.routerlogin.net> or <http://www.routerlogin.com>.

A login screen displays.

3. Enter the router user name and password.

The user name is **admin**. The default password is **password**. The user name and password are case-sensitive.

The BASIC Home screen displays.

4. Select **ADVANCED > Administration > Backup Settings**.

The screenshot shows the 'Backup Settings' page. It is divided into three horizontal sections by blue lines. The first section is titled 'Save a copy of current settings' and contains a blue 'Back Up' button. The second section is titled 'Restore saved settings from a file' and contains a text input field, a blue 'Browse' button, and a blue 'Restore' button. The third section is titled 'Revert to factory default settings' and contains a blue 'Erase' button.

5. Click the **Back Up** button.
6. If your computer prompts you to choose a location for the settings file, specify a location on your computer and click the **Save** button.

A copy of the current settings is saved to your computer.



## Restore Configuration Settings

➤ **To restore configuration settings that you backed up:**

1. Launch an Internet browser from a computer or wireless device that is connected to the network.
2. Type **http://www.routerlogin.net** or **http://www.routerlogin.com**.  
A login screen displays.
3. Enter the router user name and password.  
The user name is **admin**. The default password is **password**. The user name and password are case-sensitive.  
The BASIC Home screen displays.
4. Select **ADVANCED > Administration > Backup Settings**.  
The Backup Settings screen displays.
5. Click the **Browse** button to find and select the `.cfg` file.
6. Click the **Restore** button.  
The file is uploaded to the router and the router reboots.



**WARNING:**

**Do not interrupt the whole reboot process.**

## Erase the Current Configuration Settings

You can erase the current configuration and restore the factory default settings. You might want to do this if you move the router to a different network. (See *Factory Settings* on page 178.)

➤ **To erase the configuration settings:**

1. Launch an Internet browser from a computer or wireless device that is connected to the network.
2. Type **http://www.routerlogin.net** or **http://www.routerlogin.com**.  
A login screen displays.
3. Enter the router user name and password.  
The user name is **admin**. The default password is **password**. The user name and password are case-sensitive.  
The BASIC Home screen displays.
4. Select **ADVANCED > Administration > Backup Settings**.  
The Backup Settings screen displays.

5. Click the **Erase** button.

The factory default settings are restored. The user name is admin, the password is password, and the LAN IP address is 192.168.1.1. DHCP is enabled.

## Remote Management

You can access your router over the Internet to view or change its settings. You must know the router's WAN IP address to use this feature. For information about remote access using Dynamic DNS, see *Chapter 7, Access the Router's USB Drive Through the Internet*.

---

**Note:** Be sure to change the password for the user name admin to a secure password. The ideal password contains no dictionary words from any language and contains uppercase and lowercase letters, numbers, and symbols. It can be up to 30 characters. See *Change the admin Password* on page 132.

---

### ➤ To set up remote management:

1. Launch an Internet browser from a computer or wireless device that is connected to the network.
2. Type <http://www.routerlogin.net> or <http://www.routerlogin.com>.

A login screen displays.

3. Enter the router user name and password.

The user name is **admin**. The default password is **password**. The user name and password are case-sensitive.

The BASIC Home screen displays.

4. Select **ADVANCED > Advanced Setup > Remote Management**.

The screenshot shows the 'Remote Management' configuration page. At the top, there are 'Apply' and 'Cancel' buttons. Below them is a checkbox labeled 'Turn Remote Management On'. Underneath, the 'Remote Management Address' is set to 'https://0.0.0.0:8443'. The 'Allow Remote Access By:' section has three radio button options: 'Only This Computer' (with four empty IP address boxes), 'IP Address Range' (with 'From' and 'To' labels and two sets of four empty IP address boxes), and 'Everyone' (which is selected). At the bottom, the 'Port Number' is set to '8443'.

5. Select the **Turn Remote Management On** check box.

6. In the Allow Remote Access By section, specify the external IP addresses to be allowed to access the router's remote management.

**Note:** For enhanced security, restrict access to as few external IP addresses as practical.

Select one of the following:

- **Only this computer.** Allow access from a single IP address on the Internet. Enter the IP address to be allowed access.
  - **IP Address Range.** Allow access from a range of IP addresses on the Internet. Enter a beginning IP address and an ending IP address to define the allowed range.
  - **Everyone.** Allow access from any IP address on the Internet.
7. Specify the port number for accessing the web management interface.

Normal web browser access uses the standard HTTP service port 80. For greater security, enter a custom port number for the remote web management interface. Choose a number from 1024 to 65535, but do not use the number of any common service port. The default is 8080, which is a common alternate for HTTP.

8. Click the **Apply** button.

Your changes take effect.

➤ **To use remote access:**

1. Launch an Internet browser on a computer that is not on your home network.
2. Type your router's WAN IP address into your browser's address or location field followed by a colon (:) and the custom port number.

For example, if your external address is 134.177.0.123 and you use port number 8080, enter **http://134.177.0.123:8080** in your browser.

## 12 Use VPN to Access Your Network

---

# 12

You can use OpenVPN software to remotely access your router using virtual private networking (VPN). This chapter explains how to set up and use VPN access.

This chapter includes the following sections:

- *Set Up a VPN Connection*
- *Specify VPN Service in the Router*
- *Install OpenVPN Software on Your Computer*
- *Use a VPN Tunnel*
- *Use VPN to Access the Router's USB Drive and Media*
- *Use VPN to Access Your Internet Service at Home*

## Set Up a VPN Connection

A virtual private network (VPN) lets you use the Internet to securely access your network when you aren't home.

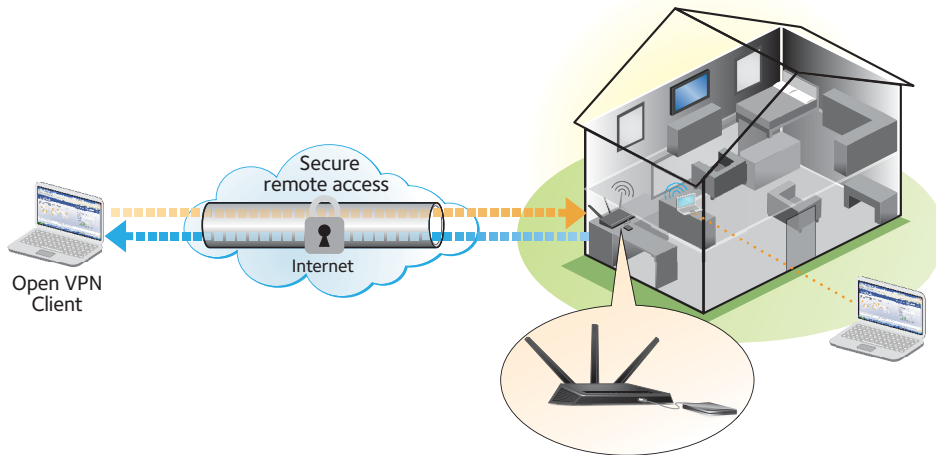

**Figure 14.** VPN provides a secure tunnel between your home network and a remote computer

This type of VPN access is called a client-to-gateway tunnel. The computer is the client, and the router is the gateway. To use the VPN feature, you must log in to the router and enable VPN, and you must install and run VPN client software on the computer.

---

**Note:** The router currently does not support iOS or Android VPN client software.

---

VPN uses DDNS or a static IP address to connect with your router.

To use a DDNS service, register for an account with a host name (sometimes called a domain name). You use the host name to access your network. The router supports these accounts: NETGEAR [www.no-ip.com](http://www.no-ip.com), [www.no-ip.com](http://www.no-ip.com), and [www.DynDNS.org](http://www.DynDNS.org).

If your Internet service provider (ISP) assigned a static WAN IP address (such as 50.196.x.x or 10.x.x.x) that never changes to your Internet account, the VPN can use that IP address to connect to your home network.

## Specify VPN Service in the Router

You must specify the VPN service settings in the router before you can use a VPN connection.

➤ **To specify the VPN service:**

1. Launch an Internet browser from a computer or wireless device that is connected to the network.

2. Type <http://www.routerlogin.net> or <http://www.routerlogin.com>.

A login screen displays.

3. Enter the router user name and password.

The user name is **admin**. The default password is **password**. The user name and password are case-sensitive.

The BASIC Home screen displays.

4. Select **ADVANCED > Advanced Setup > VPN Service**.

The VPN Service screen displays.

5. Select the **Enable VPN Service** check box.

By default, the VPN uses the UDP service type and uses port 12974. If you want to customize the service type and port, NETGEAR recommends that you change these settings before you install the OpenVPN software.

6. To change the service type, scroll down and select the **TCP** radio button.

7. To change the port, scroll down to the **Service Port** field, and type the port number that you want to use.

8. Click the **Apply** button.

Your changes are saved. VPN is enabled in the router, but you must install and set up OpenVPN software on your computer before you can use a VPN connection.

## Install OpenVPN Software on Your Computer

You must install this software on each computer that you plan to use for VPN connections to your router.

➤ **To install VPN client software:**

1. Visit <http://openvpn.net/index.php/download/community-downloads.html>.

2. In the Windows Installer section of the screen, double-click the **openVPN-install-xxx.exe** link.

3. Download the file.

4. To install the OpenVPN software on your computer, click the `openVPN-install-xxx.exe` file.

The OpenVPN Setup Wizard displays:

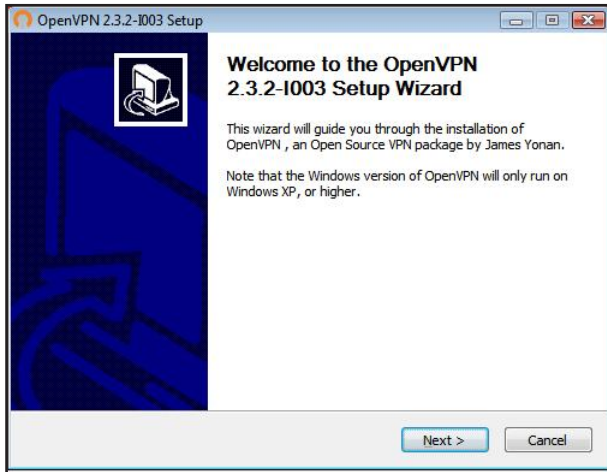

5. Click the **Next** button.
6. Read the License Agreement and click the **I Agree** button.

The Choose Components screen displays:

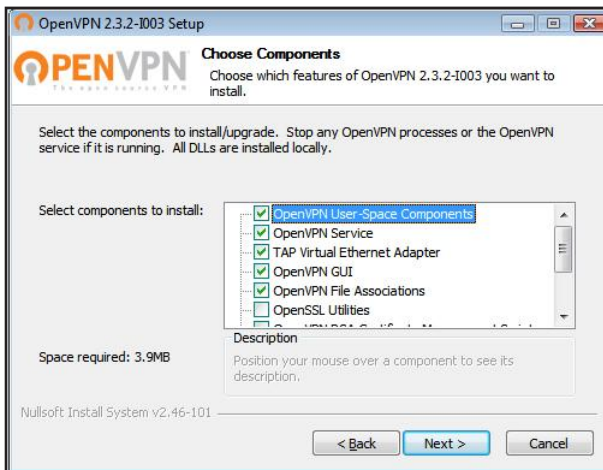

7. Leave the check boxes selected as shown, and click the **Next** button.
8. To specify the destination folder, click the **Browse** button and select a destination folder.

The following screen displays:



9. Click the **Install** button.

The screen displays the progress of the installation and then displays the final installation screen.



10. Click the **Finish** button.
11. Unzip the configuration files that you downloaded and copy them to the folder where the VPN client is installed on your device.

For a client device with Windows 64-bit system, the VPN client is installed at `C:\Program files\OpenVPN\config\` by default.

12. For a client device with Windows, modify the VPN interface name to **NETGEAR-VPN**:
  - a. In Windows, select **Start > Control Panel > Network and Internet > Network Connections**.
  - b. In the Local Area Connection list, find the local area connection with the device name **TAP-Windows Adapter**.
  - c. Select the local area connection and change its name (not its device name) to **NETGEAR-VPN**.

If you do not change the VPN interface name, the VPN tunnel connection will fail.



## Use a VPN Tunnel

After you set up the router to use VPN and install the OpenVPN application on your computer, you can open a VPN tunnel from your computer to your router over the Internet.

For the VPN tunnel to work, the local LAN IP address of the remote R6700 router must use a different LAN IP scheme from that of the local LAN where your VPN client computer is connected. If both networks use the same LAN IP scheme, when the VPN tunnel is established, you cannot access your home router or your home network with the OpenVPN software.

The default LAN IP address scheme for the R6700 router is 192.x.x.x. The most common IP schemes are 192.x.x.x, 172.x.x.x, and 10.x.x.x. If you experience a conflict, change the IP scheme either for your home network or for the network with the client VPN computer. For information about changing these settings, see [Change the LAN TCP/IP Settings](#) on page 107.

### ➤ To open a VPN tunnel:

1. Launch the OpenVPN application with administrator privileges.

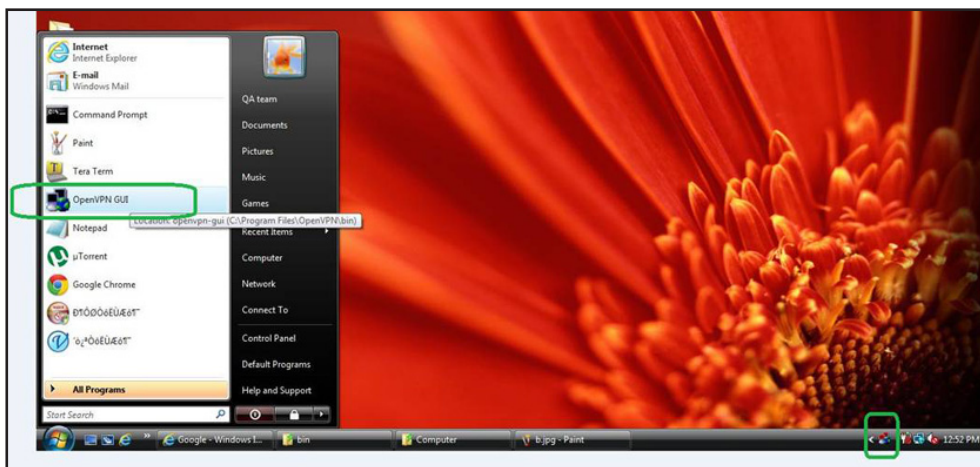

The **OpenVPN** icon displays in the Windows taskbar.

**Tip:** You can create a shortcut to the VPN program, then use the shortcut to access the settings and select the **run as administrator** check box. Then every time you use this shortcut, OpenVPN automatically runs with administrator privileges.

2. Right-click the **OpenVPN** icon.

A menu displays:

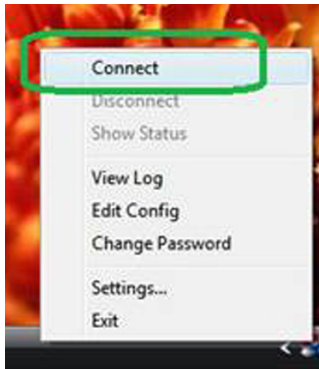

3. Select **Connect**.

The VPN connection is established. You can do the following:

- Launch an Internet browser and log in to your router.
- Use Windows file manager to access the router's USB drive and download files.

## Use VPN to Access the Router's USB Drive and Media

➤ To access the router's USB drive and download files:

1. In Windows file manager, select the **Network** folder.

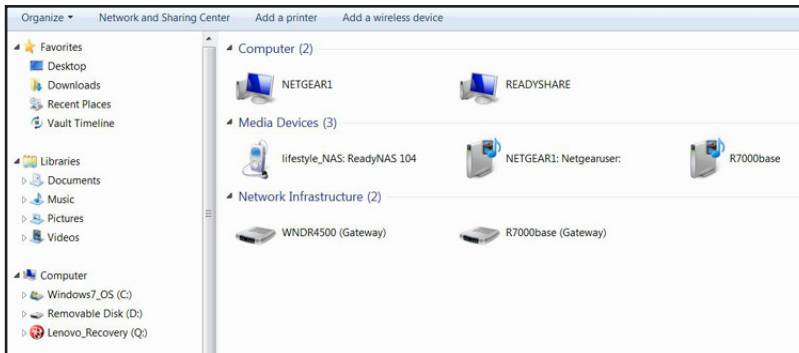

The network resources display. The ReadySHARE icon is in the Computer section and the remote R7000 icon is in the Media Devices section (if DLNA is enabled in the router).

2. If the icons do not display, click the **Refresh** button to update the screen.

If the local LAN and the remote LAN are using the same IP scheme, the remote R6700 icon does not display in the Media Devices and Network Infrastructure sections.

3. To access the router's USB drive, click the **ReadySHARE** icon.

4. To access media on the router's network, click the **R6700** icon.

## Use VPN to Access Your Internet Service at Home

When you're away from home and you access the Internet, you usually use a local Internet service provider. For example, at a coffee shop you might be given a code that lets you use the coffee shop's Internet service account to surf the web.

Nighthawk lets you use a VPN connection to access your own Internet service when you're away from home. You might want to do this if you travel to a geographic location that doesn't support all the Internet services that you use at home. For example, your Netflix account might work at home, but not in a different country.

### Set Up VPN Client Internet Access in the Router

By default, the router is set up to allow VPN connections only to your home network, but you can change the setting to allow Internet access. Accessing the Internet remotely through a VPN might be slower than accessing the Internet directly.

#### ➤ To allow VPN clients to use your home Internet service:

1. Launch an Internet browser from a computer or wireless device that is connected to the network.
2. Type <http://www.routerlogin.net> or <http://www.routerlogin.com>.

A login screen displays.

3. Enter the router user name and password.

The user name is **admin**. The default password is **password**. The user name and password are case-sensitive.

The BASIC Home screen displays.

4. Select **ADVANCED > Advanced Setup > VPN Service**.

The VPN screen displays.

5. Select the **Enable VPN Service** radio button.
6. Scroll down to the Clients will use this VPN connection to access section, and select the **All sites on the Internet & Home Network** radio button.

When you access the Internet with the VPN connection, instead of using a local Internet service, you use the Internet service from your home network.

7. Click the **Apply** button.

Your settings are saved.

8. Click the **For Windows** or **For Non Windows** button and download the configuration files for your VPN clients.
9. Unzip the configuration files and copy them to the folder where the VPN client is installed on your device.

For a client device with Windows 64-bit system, the VPN client is installed at  
C:\Program files\OpenVPN\config\ by default.

## Block VPN Client Internet Access in the Router

By default, the router is set up to allow VPN connections only to your home network, not to the Internet service for your home network. If you changed this setting to allow Internet access, you can change it back.

➤ **To allow VPN clients to access only your home network:**

1. Launch an Internet browser from a computer or wireless device that is connected to the network.
2. Type **http://www.routerlogin.net** or **http://www.routerlogin.com**.

A login screen displays.

3. Enter the router user name and password.

The user name is **admin**. The default password is **password**. The user name and password are case-sensitive.

The BASIC Home screen displays.

4. Select **ADVANCED > Advanced Setup > VPN Service**.

The VNP screen displays.

5. Select the **Enable VPN Service** radio button.
6. Scroll down to the Clients will use this VPN connection to access section and select the **Home Network only** radio button.

This is the default setting. The VPN connection is only to your home network, not to the Internet service for your home network.

7. Click the **Apply** button.

Your settings are saved.

8. Click the **For Windows** or **For Non Windows** button and download the configuration files for your VPN clients.

9. Unzip the configuration files and copy them to the folder where the VPN client is installed on your device.

For a client device with Windows 64-bit system, the VPN client is installed at  
C:\Program files\OpenVPN\config\ by default.

## Use a VPN Tunnel to Access Your Internet Service at Home

➤ **To access your Internet service:**

1. Set up the router to allow VPN access to your Internet service.

See *Set Up VPN Client Internet Access in the Router* on page 155.

2. On your computer, launch the OpenVPN application.  
The **OpenVPN** icon displays in the Windows taskbar.
3. Right-click the icon, and select **Connect**.
4. When the VPN connection is established, launch your Internet browser.

# 13 Specify Internet Port Settings

---

# 13

You can use port forwarding and port triggering to set up rules for Internet traffic. You need networking knowledge to set up these features.

This chapter includes the following sections:

- *Set Up Port Forwarding to a Local Server*
- *Set Up Port Triggering*

## Set Up Port Forwarding to a Local Server

If your home network includes a server, you can allow certain types of incoming traffic to reach the server. For example, you might want to make a local web server, FTP server, or game server visible and available to the Internet.

The router can forward incoming traffic with specific protocols to computers on your local network. You can specify the servers for applications and you can also specify a default DMZ server to which the router forwards all other incoming protocols.

### ➤ To forward specific incoming protocols:

1. Decide which type of service, application, or game you want to provide.
2. Find the local IP address of the computer on your network that will provide the service.

You can usually find this information by contacting the publisher of the application or user groups or news groups.

The server computer must always use the same IP address. Assign the server computer a reserved IP address. See [Reserve LAN IP Addresses](#) on page 111.

3. Launch an Internet browser from a computer or wireless device that is connected to the network.
4. Type <http://www.routerlogin.net> or <http://www.routerlogin.com>.

A login screen displays.

5. Enter the router user name and password.

The user name is **admin**. The default password is **password**. The user name and password are case-sensitive.

The BASIC Home screen displays.

6. Select **ADVANCED > Advanced Setup > Port Forwarding/Port Triggering**.

Port Forwarding / Port Triggering

Please select the service type.

Port Forwarding  
 Port Triggering

Service Name: FTP Server IP Address: 192.168.1

#	Service Name	External Start Port	External End Port	Internal Start Port	Internal End Port	Internal IP address

Edit Service Delete Service

+Add Custom Service

7. Leave the **Port Forwarding** radio button selected as the service type.
8. In the **Service Name** list, select the service name.

If the service that you want to add is not in the list, create a custom service. See [Add a Custom Port Forwarding Service](#) on page 160.

9. In the **Server IP Address** field, enter the IP address of the computer that will provide the service.
10. Click the **Add** button.  
The service displays in the list.

## Add a Custom Port Forwarding Service

➤ **To add a custom service:**

1. Find out which port number or range of numbers the application uses.  
You can usually find this information by contacting the publisher of the application or user groups or news groups.
2. Launch an Internet browser from a computer or wireless device that is connected to the network.
3. Type **http://www.routerlogin.net** or **http://www.routerlogin.com**.  
A login screen displays.
4. Enter the router user name and password.  
The user name is **admin**. The default password is **password**. The user name and password are case-sensitive.  
The BASIC Home screen displays.
5. Select **ADVANCED > Advanced Setup > Port Forwarding/Port Triggering**.  
The Port Forwarding/Port Triggering screen displays.
6. Leave the **Port Forwarding** radio button selected as the service type.
7. Click the **Add Custom Service** button.

Ports - Custom Services

Apply Cancel

Service Name

Service Type TCP/UDP

External Starting Port  (1~65535)

External Ending Port  (1~65535)

Use the same port range for Internal port

Internal Starting Port  (1~65535)

Internal Ending Port

Internal IP address  192  168  1

Or select from currently attached devices

	IP Address	Device Name
<input type="radio"/>	192.168.1.2	TECHPUBS

8. In the **Service Name** field, enter a descriptive name.
9. In the **Service Type** field, select the protocol.  
If you are unsure, select **TCP/UDP**.
10. In the **External Starting Port** field, enter the beginning port number.



11. If the application uses a single port, enter the same port number in the **External Ending Port** field.

If the application uses a range of ports, enter the ending port number of the range in the **External Ending Port** field.

12. Specify the internal ports by one of these methods:
  - Leave the **Use the same port range for Internal port** check box selected.
  - Type the port numbers in the **Internal Starting Port** and **Internal Ending Port** fields.
13. In the **Internal IP address** field, type the IP address or select the radio button for an attached device listed in the table.
14. Click the **Apply** button.

The service is now in the list on the Port Forwarding/Port Triggering screen.

## Edit a Port Forwarding Service

### ➤ To edit a port forwarding entry:

1. Launch an Internet browser from a computer or wireless device that is connected to the network.
2. Type <http://www.routerlogin.net> or <http://www.routerlogin.com>.  
A login screen displays.
3. Enter the router user name and password.  
The user name is **admin**. The default password is **password**. The user name and password are case-sensitive.  
The BASIC Home screen displays.
4. Select **ADVANCED > Advanced Setup > Port Forwarding/Port Triggering**.  
The Port Forwarding/Port Triggering screen displays.
5. Leave the **Port Forwarding** radio button selected as the service type.
6. In the table, select the radio button next to the service name.
7. Click the **Edit Service** button.  
The Ports - Custom Services screen displays.
8. Change the settings as needed.
9. Click the **Apply** button.  
Your changes are saved.

## Delete a Port Forwarding Entry

➤ **To delete a port forwarding entry:**

1. Launch an Internet browser from a computer or wireless device that is connected to the network.
2. Type **http://www.routerlogin.net** or **http://www.routerlogin.com**.  
A login screen displays.
3. Enter the router user name and password.  
The user name is **admin**. The default password is **password**. The user name and password are case-sensitive.  
The BASIC Home screen displays.
4. Select **ADVANCED > Advanced Setup > Port Forwarding/Port Triggering**.  
The Port Forwarding/Port Triggering screen displays.
5. Select the **Port Forwarding** radio button as the service type.
6. In the table, select the radio button next to the service name.
7. Click the **Delete Service** button.  
The service is deleted.

## Application Example: Make a Local Web Server Public

If you host a web server on your local network, you can use port forwarding to allow web requests from anyone on the Internet to reach your web server.

➤ **To make a local web server public:**

1. Assign your web server either a fixed IP address or a dynamic IP address using DHCP address reservation.  
In this example, your router always gives your web server an IP address of 192.168.1.33.
2. In the Port Forwarding/Port Triggering screen, configure the router to forward the HTTP service to the local address of your web server at **192.168.1.33**.  
HTTP (port 80) is the standard protocol for web servers.
3. (Optional) Register a host name with a Dynamic DNS service, and specify that name in the Dynamic DNS screen of the router.  
Dynamic DNS makes it much easier to access a server from the Internet because you can type the name in the Internet browser. Otherwise, you must know the IP address that the ISP assigned, which typically changes.

## How the Router Implements the Port Forwarding Rule

The following sequence shows the effects of a port forwarding rule:

1. When you type the URL `www.example.com` in your browser, the browser sends a web page request message with the following destination information:
  - **Destination address.** The IP address of `www.example.com`, which is the address of your router.
  - **Destination port number.** 80, which is the standard port number for a web server process.
2. Your router receives the message and finds your port forwarding rule for incoming port 80 traffic.
3. The router changes the destination in the message to IP address 192.168.1.123 and sends the message to that computer.
4. Your web server at IP address 192.168.1.123 receives the request and sends a reply message to your router.
5. Your router performs Network Address Translation (NAT) on the source IP address, and sends the reply through the Internet to the computer or wireless device that sent the web page request.

## Set Up Port Triggering

Port triggering is a dynamic extension of port forwarding that is useful in these cases:

- An application must use port forwarding to more than one local computer (but not simultaneously).
- An application must open incoming ports that are different from the outgoing port.

With port triggering, the router monitors traffic to the Internet from an outbound “trigger” port that you specify. For outbound traffic from that port, the router saves the IP address of the computer that sent the traffic. The router temporarily opens the incoming port or ports that you specify in your rule and forwards that incoming traffic to that destination.

Port forwarding creates a static mapping of a port number or range of ports to a single local computer. Port triggering can dynamically open ports to any computer when needed and close the ports when they are no longer needed.

---

**Note:** If you use applications such as multiplayer gaming, peer-to-peer connections, real-time communications such as instant messaging, or remote assistance (a feature in Windows XP), enable Universal Plug and Play (UPnP). See *Improve Network Connections with Universal Plug and Play* on page 53.

---

## Add a Port Triggering Service

➤ **To add a port triggering service:**

1. Launch an Internet browser from a computer or wireless device that is connected to the network.

2. Type **http://www.routerlogin.net** or **http://www.routerlogin.com**.

A login screen displays.

3. Enter the router user name and password.

The user name is **admin**. The default password is **password**. The user name and password are case-sensitive.

The BASIC Home screen displays.

4. Select **ADVANCED > Advanced Setup > Port Forwarding/Port Triggering**.

The Port Forwarding/Port Triggering screen displays.

5. Select the **Port Triggering** radio button.

6. Click the **Add Service** button.

7. In the **Service Name** field, type a descriptive service name.

8. From the **Service User** list, select a user option:

- **Any** (the default) allows any computer on the Internet to use this service.
- **Single address** restricts the service to a particular computer.

9. From the **Service Type** list, select **TCP** or **UDP** or **TCP/UDP** (both).

If you are not sure, select **TCP/UDP**.

10. In the **Triggering Port** field, enter the number of the outbound traffic port that will open the inbound ports.

11. In the **Connection Type**, **Starting Port**, and **Ending Port** fields, enter the inbound connection port information.

12. Click the **Apply** button.

The service is added. You must enable port triggering before the router uses port triggering for the service that you added. See [Enable Port Triggering](#) on page 165.

## Enable Port Triggering

### ➤ To enable port triggering:

1. Launch an Internet browser from a computer or wireless device that is connected to the network.
2. Type <http://www.routerlogin.net> or <http://www.routerlogin.com>.

A login screen displays.

3. Enter the router user name and password.

The user name is **admin**. The default password is **password**. The user name and password are case-sensitive.

The BASIC Home screen displays.

4. Select **ADVANCED > Advanced Setup > Port Forwarding/Port Triggering**.

The Port Forwarding/Port Triggering screen displays.

5. Select the **Port Triggering** radio button.

6. Clear the **Disable Port Triggering** check box.

If this check box is selected, the router does not use port triggering even if you have specified port triggering settings.

7. In the **Port Triggering Timeout** field, enter a value up to 9999 minutes.

This value controls how long the inbound ports stay open when the router detects no activity. This value is required because the router cannot detect when the application terminates.

## Application Example: Port Triggering for Internet Relay Chat

Some application servers, such as FTP and IRC servers, send replies to multiple port numbers. Using port triggering, you can tell the router to open more incoming ports when a particular outgoing port starts a session.

An example is Internet Relay Chat (IRC). Your computer connects to an IRC server at destination port 6667. The IRC server not only responds to your originating source port, but

also sends an “identify” message to your computer on port 113. Using port triggering, you can tell the router, “When you initiate a session with destination port 6667, you must also allow incoming traffic on port 113 to reach the originating computer.” The following sequence shows the effects of this port triggering rule:

1. You open an IRC client program to start a chat session on your computer.
2. Your IRC client composes a request message to an IRC server using a destination port number of 6667, the standard port number for an IRC server process. Your computer then sends this request message to your router.
3. Your router creates an entry in its internal session table describing this communication session between your computer and the IRC server. Your router stores the original information, performs Network Address Translation (NAT) on the source address and port, and sends this request message through the Internet to the IRC server.
4. Noting your port triggering rule and observing the destination port number of 6667, your router creates another session entry to send any incoming port 113 traffic to your computer.
5. The IRC server sends a return message to your router using the NAT-assigned source port (for example, port 33333) as the destination port and sends an “identify” message to your router with destination port 113.
6. When your router receives the incoming message to destination port 33333, it checks its session table to see if a session is active for port number 33333. Finding an active session, the router restores the original address information replaced by NAT and sends this reply message to your computer.
7. When your router receives the incoming message to destination port 113, it checks its session table and finds an active session for port 113 associated with your computer. The router replaces the message’s destination IP address with your computer’s IP address and forwards the message to your computer.
8. When you finish your chat session, your router eventually senses a period of inactivity in the communications. The router then removes the session information from its session table, and incoming traffic is no longer accepted on port numbers 33333 or 113.

This chapter provides information to help you diagnose and solve problems you might experience with your router. If you do not find the solution here, check the NETGEAR support site at <http://support.netgear.com> for product and contact information.

This chapter contains the following sections:

- *Quick Tips*
- *Troubleshoot with the LEDs*
- *Cannot Log In to the Router*
- *Cannot Access the Internet*
- *Changes Not Saved*
- *Wireless Connectivity*
- *Troubleshoot Your Network Using the Ping Utility*

## Quick Tips

See the following for tips for troubleshooting some common problems:

- *Sequence to Restart Your Network* on page 168
- *Check Ethernet Cable Connections* on page 168
- *Wireless Settings* on page 168
- *Network Settings* on page 168

## Sequence to Restart Your Network

When you must to restart your network, follow this sequence:

1. Turn off *and* unplug the modem.
2. Turn off the router.
3. Plug in the modem and turn it on. Wait two minutes.
4. Turn on the router and wait two minutes.

## Check Ethernet Cable Connections

If your device does not power on, make sure that the Ethernet cables are securely plugged in. The Internet LED on the router is lit if the Ethernet cable connecting the router and the modem is plugged in securely and the modem and router are turned on. If one or more powered-on computers are connected to the router by an Ethernet cable, the corresponding numbered router LAN port LEDs light.

## Wireless Settings

Make sure that the wireless settings in the computer and router match exactly. The wireless network name (SSID) and wireless security settings of the router and wireless computer must match exactly.

If you set up an access list in the Advanced Wireless Settings screen, you must add each wireless computer's MAC address to the router's access list.

## Network Settings

Make sure that the network settings of the computer are correct. Wired and wirelessly connected computers must use network (IP) addresses on the same network as the router. The simplest way to do this is to configure each computer to obtain an IP address automatically using DHCP.

Some cable modem service providers require you to use the MAC address of the computer initially registered on the account. You can view the MAC address in the Attached Devices screen.



## Troubleshoot with the LEDs

By default, the router is set with standard LED settings. If you disabled blinking for the LEDs or turned off all LEDs except the Power LED, you must return the LEDs to their standard settings for troubleshooting. For information about controlling the LED settings, see [Disable LED Blinking or Turn Off LEDs](#) on page 104.

### Standard LED Behavior When the Router Is Powered On

After you turn on power to the router, the following sequence of events occurs:

1. When power is first applied, verify that the Power LED  is lit.
2. After approximately 30 seconds, verify the following:
  - The Power LED is solid white.
  - The Internet LED is lit.
  - The WiFi LED is lit unless you turned off the wireless radio.

You can use the LEDs on the front panel of the router for troubleshooting.

### Power LED Is Off or Blinking

If the Power LED is off or blinking, try the following:

- Make sure that the power adapter is securely connected to your router and securely connected to a working power outlet.
- Check that you are using the power adapter that NETGEAR supplied for this product.
- If the Power LED blinks slowly and continuously, the router firmware is corrupted. This can happen if a firmware upgrade is interrupted or if the router detects a problem with the firmware. If the error persists, a hardware problem exists. For recovery instructions, or help with a hardware problem, contact technical support at [www.netgear.com/support](http://www.netgear.com/support).

### Power LED Stays Amber

When the router is powered on, the Power LED lights amber for about 20 seconds and then lights white. If the LED does not turn white, the router is experiencing a problem.

If the Power LED is still amber one minute after you turn on power to the router, do the following:

1. Turn off the power and then turn it back on to see if the router recovers.
2. Press and hold the **Reset** button to return the router to its factory settings.

See [Factory Settings](#) on page 178.

If the error persists, you might be experiencing a hardware problem. Contact technical support at [www.netgear.com/support](http://www.netgear.com/support).

## LEDs Never Turn Off

When the router is turned on, the LEDs light for about 10 seconds and then turn off. If all the LEDs stay on, this indicates a fault within the router.

If all LEDs are still lit one minute after power-up, do the following:

- Cycle the power to see if the router recovers.
- Press and hold the **Reset** button to return the router to its factory settings. For more information, see *Factory Settings* on page 178.

If the error persists, you might be experiencing a hardware problem. Contact technical support at [www.netgear.com/support](http://www.netgear.com/support).

## Internet or Ethernet Port LEDs Are Off

If either the Ethernet port LEDs or the Internet LED does not light when the Ethernet connection is made, check the following:

- Make sure that the Ethernet cable connections are secure at the router and at the modem or computer.
- Make sure that power is turned on to the connected modem or computer.
- Be sure that you are using the correct cable.

When connecting the router's Internet port to a cable or DSL modem, use the cable that was supplied with the cable or DSL modem. This cable can be a standard straight-through Ethernet cable or an Ethernet crossover cable.

## WiFi LED Is Off

If the WiFi LED stays off, check to see if the **WiFi On/Off** button on the router was pressed. This button turns the wireless radios in the router on and off. The WiFi LED is lit when the wireless radios are turned on.

## Cannot Log In to the Router

If you are unable to log in to the router from a computer on your local network, check the following:

- If you are using an Ethernet-connected computer, check the Ethernet connection between the computer and the router.
- Make sure that the IP address of your computer is on the same subnet as the router. If you are using the recommended addressing scheme, your computer's address is in the range of 192.168.1.2 to 192.168.1.254.
- If your computer's IP address is shown as 169.254.x.x, recent versions of Windows and Mac OS generate and assign an IP address if the computer cannot reach a DHCP server. These autogenerated addresses are in the range of 169.254.x.x. If your IP address is in

this range, check the connection from the computer to the router, and reboot your computer.

- If your router's IP address was changed and you do not know the current IP address, clear the router's configuration to factory defaults. This sets the router's IP address to 192.168.1.1. For more information, see *Factory Settings* on page 178.
- Make sure that Java, JavaScript, or ActiveX is enabled in your browser. If you are using Internet Explorer, click the **Refresh** button to be sure that the Java applet is loaded.
- Try quitting the browser and launching it again.
- Make sure that you are using the correct login information. The user name is **admin**, and the default password is **password**. Make sure that Caps Lock is off when you enter this information.
- If you are attempting to set up your NETGEAR behind an existing router in your network, use bridge mode or set up the router as an access point.
- If you are attempting to set up your NETGEAR router as a replacement for an ADSL gateway in your network, the router cannot perform many gateway services. For example, the router cannot convert ADSL or cable data into Ethernet networking information. NETGEAR does not support such a configuration.

## Cannot Access the Internet

If you can access your router but not the Internet, check to see if the router can obtain an IP address from your Internet service provider (ISP). Unless your ISP provides a fixed IP address, your router requests an IP address from the ISP. You can determine whether the request was successful using the Router Status screen.

### ➤ To check the WAN IP address:

1. Launch an Internet browser from a computer or wireless device that is connected to the network.
2. Type **http://www.routerlogin.net** or **http://www.routerlogin.com**.  
A login screen displays.
3. Enter the router user name and password.  
The user name is **admin**. The default password is **password**. The user name and password are case-sensitive.  
The BASIC Home screen displays.
4. Click the **ADVANCED** tab.  
The ADVANCED Home screen displays.
5. Check that an IP address is shown for the Internet port. If 0.0.0.0 is shown, your router did not obtain an IP address from your ISP.

If your router cannot obtain an IP address from the ISP, you might need to force your cable or DSL modem to recognize your new router by restarting your network. For more information, see *Sequence to Restart Your Network* on page 168.

If your router is still unable to obtain an IP address from the ISP, the problem might be one of the following:

- Your Internet service provider (ISP) might require a login program. Ask your ISP whether they require PPP over Ethernet (PPPoE) or some other type of login.
- If your ISP requires a login, the login name and password might be set incorrectly.
- Your ISP might check for your computer's host name. Assign the computer host name of your ISP account as the account name in the Internet Setup screen.
- If your ISP allows only one Ethernet MAC address to connect to Internet and checks for your computer's MAC address do one of the following:
  - Inform your ISP that you have bought a new network device, and ask them to use the router's MAC address.
  - Configure your router to clone your computer's MAC address.

If your router was assigned an IP address but your computer does not load any web pages from the Internet, it might be due to one or more of the following reasons:

- Your computer might not recognize any DNS server addresses.  
A DNS server is a host on the Internet that translates Internet names (such as www addresses) to numeric IP addresses. Typically, your ISP provides the addresses of one or two DNS servers for your use. If you entered a DNS address during the router's configuration, reboot your computer, and verify the DNS address. You can configure your computer manually with DNS addresses, as explained in your operating system documentation.
- The router might not be configured as the TCP/IP gateway on your computer.  
If your computer obtains its information from the router by DHCP, reboot the computer, and verify the gateway address.
- You might be running login software that is no longer needed.  
If your ISP provided a program to log you in to the Internet (such as WinPoET), you no longer need to run that software after installing your router. You might need to go to Internet Explorer and select **Tools > Internet Options**, click the **Connections** tab, and select the **Never dial a connection** radio button.

## Troubleshoot PPPoE

If you are using PPPoE, try troubleshooting your Internet connection.

### ➤ To troubleshoot a PPPoE connection:

1. Launch an Internet browser from a computer or wireless device that is connected to the network.
2. Type <http://www.routerlogin.net> or <http://www.routerlogin.com>.

A login screen displays.

3. Enter the router user name and password.

The user name is **admin**. The default password is **password**. The user name and password are case-sensitive.

The BASIC Home screen displays.

4. Click the **ADVANCED** tab.

The ADVANCED Home screen displays.

5. Click the **Connection Status** button.

The Connection Status screen displays.

6. Check the Connection Status screen to see if your PPPoE connection is working.

If you are not connected, click the **Connect** button.

The router continues to attempt to connect indefinitely.

7. If you cannot connect after several minutes, the router might be set up with an incorrect service name, user name, or password, or your ISP might be experiencing a provisioning problem.

Unless you connect manually, the router does not authenticate using PPPoE until data is transmitted to the network.

## Troubleshoot Internet Browsing

If your router can obtain an IP address but your computer is unable to load any web pages from the Internet, check the following:

- Your computer might not recognize any DNS server addresses. A DNS server is a host on the Internet that translates Internet names (such as www addresses) to numeric IP addresses.

Typically, your ISP provides the addresses of one or two DNS servers for your use. If you entered a DNS address during the router's configuration, restart your computer.

Alternatively, you can configure your computer manually with a DNS address, as explained in the documentation for your computer.

- The router might not be configured as the default gateway on your computer.

Reboot the computer and verify that the router address (www.routerlogin.net) is listed by your computer as the default gateway address.

- You might be running login software that is no longer needed. If your ISP provided a program to log you in to the Internet (such as WinPoET), you no longer need to run that software after installing your router. You might need to go to Internet Explorer and select **Tools > Internet Options**, click the **Connections** tab, and select the **Never dial a connection** radio button.

## Changes Not Saved

If the router does not save the changes you make in the router interface, do the following:

- When entering configuration settings, always click the **Apply** button before moving to another screen or tab or your changes are lost.
- Click the **Refresh** or **Reload** button in the web browser. It is possible that the changes were made, but the old settings are in the web browser's cache.

## Wireless Connectivity

If you are experiencing trouble connecting wirelessly to the router, try to isolate the problem:

- Does the wireless device or computer that you are using find your wireless network?  
If not, check the WiFi LED on the front of the router. If it is off, you can press the **WiFi On/Off** button on the router to turn the router wireless radios back on.  
If you disabled the router's SSID broadcast, then your wireless network is hidden and does not display in your wireless client's scanning list. (By default, SSID broadcast is enabled.)
- Does your wireless device support the security that you are using for your wireless network (WPA or WPA2)?
- If you want to view the wireless settings for the router, use an Ethernet cable to connect a computer to a LAN port on the router. Then log in to the router and select **BASIC > Wireless**.

**Note:** Be sure to click the **Apply** button if you change settings.

If your wireless device finds your network, but the signal strength is weak, check these conditions:

- Is your router too far from your computer or too close? Place your computer near the router, but at least 6 feet (1.8 meters) away and see whether the signal strength improves.
- Are objects between the router and your computer blocking the wireless signal?

## Troubleshoot Your Network Using the Ping Utility

Most network devices and routers contain a ping utility that sends an echo request packet to the designated device. The device then responds with an echo reply. You can easily troubleshoot a network using the ping utility in your computer or workstation.

## Test the LAN Path to Your Router

You can ping the router from your computer to verify that the LAN path to your router is set up correctly.

➤ **To ping the router from a Windows computer:**

1. From the Windows toolbar, click **Start** and select **Run**.
2. In the field provided, type **ping** followed by the IP address of the router, as in this example:  
**ping www.routerlogin.net**

3. Click the **OK** button.

You should see a message like this one:

```
Pinging <IP address > with 32 bytes of data
```

If the path is working, you see this message:

```
Reply from < IP address >: bytes=32 time=NN ms TTL=xxx
```

If the path is not working, you see this message:

```
Request timed out
```

If the path is not functioning correctly, you might be experiencing one of the following problems:

- Wrong physical connections

For a wired connection, make sure that the numbered LAN port LED is lit for the port to which you are connected.

Check that the appropriate LEDs are lit for your network devices. If your router and computer are connected to a separate Ethernet switch, make sure that the link LEDs are lit for the switch ports that are connected to your computer and router.

- Wrong network configuration

Verify that the Ethernet card driver software and TCP/IP software are both installed and configured on your computer.

Verify that the IP address for your router and your computer are correct and that the addresses are on the same subnet.

## Test the Path from Your Computer to a Remote Device

After verifying that the LAN path works correctly, test the path from your computer to a remote device.

1. From the Windows toolbar, click the **Start** button and select **Run**.
2. In the field provided, type:  
**ping -n 10 <IP address>**

where <IP address> is the IP address of a remote device such as your ISP DNS server.

If the path is functioning correctly, messages display that are similar to those shown in *Test the LAN Path to Your Router* on page 175.

If you do not receive replies, check the following:

- Check that the IP address of your router is listed on your computer as the default gateway. If DHCP assigns the IP configuration of your computers, this information is not visible in your computer Network Control Panel. Verify that the IP address of the router is listed as the default gateway.
- Check to see that the network address of your computer (the portion of the IP address specified by the subnet mask) is different from the network address of the remote device.
- Check that your cable or DSL modem is connected and functioning.
- If your ISP assigned a host name to your computer, enter that host name as the account name in the Internet Setup screen.
- Your ISP might be rejecting the Ethernet MAC addresses of all but one of your computers.

Many broadband ISPs restrict access by allowing traffic only from the MAC address of your broadband modem. Some ISPs additionally restrict access to the MAC address of a single computer connected to that modem. If your ISP does this, configure your router to “clone” or “spoof” the MAC address from the authorized computer.



# A Supplemental Information

---

# A

This appendix includes technical information about your router.

This appendix covers the following topics:

- *Factory Settings*
- *Technical Specifications*

## Factory Settings

You can return the router to its factory settings. Use the end of a paper clip or a similar object to press and hold the **Reset** button on the back of the router for at least seven seconds. The router resets, and returns to the factory configuration settings shown in the following table.

**Table 3. Factory default settings**

Feature		Default behavior
Router login	User login URL	www.routerlogin.com or www.routerlogin.net
	User name (case-sensitive)	admin
	Login password (case-sensitive)	password
Internet connection	WAN MAC address	Use default hardware address
	WAN MTU size	1500
	Port speed	AutoSensing
Local network (LAN)	LAN IP	192.168.1.1
	Subnet mask	255.255.255.0
	DHCP server	Enabled
	DHCP range	192.168.1.2 to 192.168.1.254
	Time zone	Pacific time
	DHCP starting IP address	192.168.1.2
	DHCP ending IP address	192.168.1.254
	DMZ	Disabled
	Time zone	GMT for WW except NA and GR, GMT+1 for GR, GMT-8 for NA
	Time zone adjusted for daylight savings time	Disabled
	SNMP	Disabled
Firewall	Inbound (communications coming in from the Internet)	Disabled (except traffic on port 80, the HTTP port)
	Outbound (communications going out to the Internet)	Enabled (all)
	Source MAC filtering	Disabled

**Table 3. Factory default settings (continued)**

Feature		Default behavior
Wireless	Wireless communication	Enabled
	SSID name	See router label
	Security	WPA2-PSK (AES)
	Broadcast SSID	Enabled
	Transmission speed	Auto*
	Country/region	United States in the US; otherwise varies by region
	RF channel	6 until region selected
	Operating mode	Up to 450 Mbps at 2.4 GHz, 1300 Mbps at 5 GHz

\*. Maximum wireless signal rate derived from IEEE Standard 802.11 specifications. Actual throughput can vary. Network conditions and environmental factors, including volume of network traffic, building materials and construction, and network overhead, lower actual data throughput rate.

## Technical Specifications

**Table 4. R6700 router specifications**

Feature	Description
Data and routing protocols	TCP/IP, RIP-1, RIP-2, DHCP, PPPoE, PPTP, Bigpond, Dynamic DNS, UPnP, and SMB
Power adapter	<ul style="list-style-type: none"> <li>North America: 120V, 60 Hz, input</li> <li>All regions (output): 12V/3.5A DC output</li> </ul>
Dimensions	Dimensions: 280 mm x 182 mm x 49 mm (11 in. x 7.17 in. x 1.9 in.)
Weight	Weight: 430 g (0.94 lb)
Operating temperature	0° to 40°C (32° to 104°F)
Operating humidity	90% maximum relative humidity, noncondensing
Electromagnetic emissions	FCC Part 15 Class B VCCI Class B EN 55 022 (CISPR 22), Class B C-Tick N10947
LAN	10BASE-T or 100BASE-TX or 1000BASE-T, RJ-45
WAN	10BASE-T or 100BASE-TX or 1000BASE-T, RJ-45
Wireless	Maximum wireless signal rate complies with the IEEE 802.11 standard.*
Radio data rates	Auto Rate Sensing
Data encoding standards	IEEE 802.11ac 2.0 IEEE 802.11n version 2.0 IEEE @ 802.11 b/g/n 2.4 GHz IEEE @ 802.11 a/n/ac 5.0 GHz
Maximum computers per wireless network	Limited by the amount of wireless network traffic generated by each node (typically 50–70 nodes).
Operating frequency range	2.4 GHz 2.412–2.462 GHz (US) 2.412–2.472 GHz (Japan) 2.412–2.472 GHz (Europe ETSI) 5 GHz 5.18–5.24 + 5.745–5.825 GHz (US) 5.18–5.24 GHz (Europe ETSI)
802.11 security	WPA-PSK, WPA2-PSK, and WPA/WPA2

\*. Maximum wireless signal rate derived from IEEE standard 802.11 specifications. Actual data throughput and wireless coverage will vary. Network conditions and environmental factors, including volume of network traffic, building materials and construction, and network overhead, lower actual data throughput rate and wireless coverage. NETGEAR makes no express or implied representations or warranties about this product's compatibility with any future standards. 802.11ac 1300 Mbps is approximately 3x faster than 802.11n 450 Mbps. Up to 1300 Mbps wireless speeds achieved when connecting to other 802.11ac 1300 Mbps devices.